

Public-law institution jointly founded by the  
federal states and the Federation

European Technical Assessment Body  
for construction products



## European Technical Assessment

## ETA-23/1007 of 15 January 2024

English translation prepared by DIBt - Original version in German language

### General Part

Technical Assessment Body issuing the  
European Technical Assessment:

Deutsches Institut für Bautechnik

Trade name of the construction product

blaugelb screws

Product family  
to which the construction product belongs

Screws for use in timber constructions

Manufacturer

Meesenburg KG  
Westerallee 162  
24941 Flensburg

Manufacturing plant

plant 1  
plant 2

This European Technical Assessment  
contains

42 pages including 7 annexes which form an integral part  
of this assessment

This European Technical Assessment is  
issued in accordance with Regulation (EU)  
No 305/2011, on the basis of

EAD 130118-01-0603

The European Technical Assessment is issued by the Technical Assessment Body in its official language. Translations of this European Technical Assessment in other languages shall fully correspond to the original issued document and shall be identified as such.

Communication of this European Technical Assessment, including transmission by electronic means, shall be in full. However, partial reproduction may only be made with the written consent of the issuing Technical Assessment Body. Any partial reproduction shall be identified as such.

This European Technical Assessment may be withdrawn by the issuing Technical Assessment Body, in particular pursuant to information by the Commission in accordance with Article 25(3) of Regulation (EU) No 305/2011.

## Specific Part

### 1 Technical description of the product

The anti-friction coated blaugelb WKCS, WKCP, WKPC, WKPS, WKPP, WKLC, WKCH, WKCR, WKSS, WKFC, WKFS, WKFP, WKFC-SD, WKFS-SD and WKFP-SD screws are self-tapping screws made from special carbon steel. The outer thread diameter  $d$  is not less than 3 mm and not greater than 10 mm. The overall length of the screw is ranging from 30 mm to 600 mm (nominal dimension). Further dimensions are shown in Annex 7.

All blaugelb screws achieve a bending angle  $\alpha$  of at least  $45/d^{0.7} + 20$ , where  $d$  is the outer thread diameter of the screws.

### 2 Specification of the intended use in accordance with the applicable European Assessment Document

The performances given in Section 3 are only valid if the blaugelb screws are used in compliance with the specifications and conditions given in Annex 1 and 2.

The verifications and assessment methods on which this European Technical Assessment is based lead to the assumption of a working life of the screws of at least 50 years. The indications given on the working life cannot be interpreted as a guarantee given by the producer, but are to be regarded only as a means for choosing the right products in relation to the expected economically reasonable working life of the works.

### 3 Performance of the product and references to the methods used for its assessment

#### 3.1 Mechanical resistance and stability (BWR 1)

Essential characteristic	Performance
Dimensions	See Annex 7
Characteristic yield moment	See Annex 2
Bending angle	See Annex 2
Characteristic withdrawal parameter	See Annex 2
Characteristic head pull-through parameter	See Annex 2
Characteristic tensile strength	See Annex 2
Characteristic yield strength	See Annex 2
Characteristic torsional strength	See Annex 2
Insertion moment	See Annex 2
Spacings, end and edge distances of the screws and minimum thickness of the wood-based material	See Annex 2
Slip modulus for mainly axially loaded screws	See Annex 2
Durability against corrosion	See Annex 2

**3.2 Safety in case of fire (BWR 2)**

Essential characteristic	Performance
Reaction to fire	Class A1

**3.3 Safety and accessibility in use (BWR 4)**

Same as BWR 1.

**4 Assessment and verification of constancy of performance (AVCP) system applied, with reference to its legal base**

In accordance with EAD No. 130118-01-0603, the applicable European legal act is: 97/176/EC.  
The system to be applied is: 3

**5 Technical details necessary for the implementation of the AVCP system, as provided for in the applicable EAD**

Technical details necessary for the implementation of the AVCP system are laid down in the control plan deposited with Deutsches Institut für Bautechnik.

Issued in Berlin on 15 January 2024 by Deutsches Institut für Bautechnik

Anja Dewitt  
Head of Section

*beglaubigt:*  
Deniz

## Annex 1 Specifications of intended use

### A.1.1 Use of the blaugelb screws only for:

- static and quasi-static loads

### A.1.2 Connection material

The screws are used for connections in load-bearing timber structures between wood-based members or between wood-based members and steel members:

- Solid timber (softwood) in accordance with EN 14081-1<sup>1</sup>,
- Plywood in accordance with EN 636<sup>2</sup> and EN 13986<sup>3</sup>,
- Oriented strand boards (OSB) in accordance with EN 300<sup>4</sup> and EN 13986,
- Particleboards in accordance with EN 312<sup>5</sup> and EN 13986,
- Fibreboards in accordance with EN 622-2<sup>6</sup>, EN 622-3<sup>7</sup> and EN 13986,
- Cement-bonded particleboards in accordance with EN 634-2<sup>8</sup> and EN 13986,
- Solid wood panels (SWP) in accordance with EN 13353<sup>9</sup> and EN 13986.

Wood-based panels are only arranged on the side of the screw head.

For the fixing of thermal insulation material on top of rafters or on wood-based members in vertical façades blaugelb screws with an outer thread diameter of at least 6 mm may be used.

WKFC, WKFS, WKFP and WKFC-SD, WKFS-SD, WKFP-SD screws may be used for compressive and tensile reinforcing of timber structures perpendicular to the grain. WKFC, WKFS, WKFP and WKFC-SD, WKFS-SD, WKFP-SD screws with an outer thread diameter of  $d = 8$  mm may also be used for shear reinforcement.

1	EN 14081-1:2005+A1:2011	Timber structures – Strength graded structural timber with rectangular cross section – Part 1: General requirements
2	EN 636:2012+A1:2015	Plywood – Specifications
3	EN 13986:2004+A1:2015	Wood-based panels for use in construction – Characteristics, evaluation of conformity and marking
4	EN 300:2006	Oriented strand boards (OSB) – Definition, classification and specifications
5	EN 312:2010	Particleboards – Specifications
6	EN 622-2:2004/AC:2005	Fibreboards – Specifications – Part 2: Requirements for hardboards
7	EN 622-3:2004	Fibreboards – Specifications – Part 3: Requirements for medium boards
8	EN 634-2:2007	Cement-bonded particleboards – Specifications – Part 2: Requirements for OPC bonded particleboards for use in dry, humid and external conditions
9	EN 13353:2022	Solid wood panels (SWP) – Requirements

blaugelb screws	Annex 1
Specification of intended use	

**A.1.3 Use Conditions (environmental conditions)**

The corrosion protection of the blaugelb screws is specified in Annex A.2.6.

**A.1.4 Installation provisions**

EN 1995-1-1<sup>10</sup> applies for the installation of blaugelb screws.

A minimum of two screws is used for connections in load-bearing timber structures. When fixing boards, battens or intermediate connections of wind braces only one screw may be used. This also applies for the fixing of rafters, purlins or similar on main beams or top plates, if the member is fixed with at least two screws in total.

At least four screws are used in a connection with axially loaded screws inserted in the timber member with an angle between screw axis and grain direction of less than 15°.

Only one screw may be used in structural connections when the minimum penetration length of the screw is 20·d and the screw is systematic axially loaded. In the case the screw is used to connect wood-based members the load-bearing capacity of the screw shall be reduced by 50 %. If the screw is used as tensile or compressive reinforcement of timber structures perpendicular to the grain no reduction of the load-bearing capacity of the screw is necessary.

The screws are driven into softwood without pre-drilling or after pre-drilling with a diameter not larger than the inner thread diameter for the length of the threaded part and with a maximum of the smooth shank diameter for the length of the smooth shank.

The screw holes in steel members are pre-drilled with an adequate diameter greater than the outer thread diameter.

If the screws with an outer thread diameter  $d \geq 8$  mm are driven into the wood-based member without pre-drilling, the structural solid timber, glued laminated timber, glued solid timber, laminated veneer lumber and cross laminated timber is from spruce, pine or fir.

In the case of fastening counter battens on thermal insulation material on top of rafters the screws are driven in the rafter through the counter battens and the thermal insulation material without pre-drilling in one sequence.

By fastening screws in wood-based members the head of the screws is flush with the surface of the wood-based member. For wafer head and WKLC head the head part remains unconsidered.

Screws are used with appropriate washers in accordance with Annex 7. After inserting the screws, the washers shall touch the surface of the wood-based member completely.

<sup>10</sup> EN 1995-1-1:2004/AC:2006 +A1:2008+A2:2014 Eurocode 5: Design of timber structures – Part 1-1: General – Common rules and rules for buildings

blaugelb screws	Annex 1
Installation provisions	

## Annex 2 Characteristic values of the load-carrying capacities

Table A.2.1 Characteristic load-carrying capacities of blaugelb screws

Outer thread diameter d [mm]		3.0	3.5	4.0	4.5	5.0	6.0	8.0	10.0
Characteristic yield moment $M_{y,k}$ [Nm]	All screws except WKFC, WKFS, WKFP and WKFC-SD, WKFS-SD, WKFP-SD screws	1.5	2	3.5	5	6	10	25	43
	WKFC, WKFS, WKFP and WKFC-SD, WKFS-SD, WKFP-SD screws	-	-	-	-	-	14	25	43
Characteristic tensile strength $f_{tens,k}$ [kN]	All screws except WKFC, WKFS, WKFP and WKFC-SD, WKFS-SD, WKFP-SD screws	3.5	4	6	8	9	13	25	36
	WKFC, WKFS, WKFP and WKFC-SD, WKFS-SD, WKFP-SD screws	-	-	-	-	-	16	25	36
Characteristic torsional strength $f_{tor,k}$ [Nm]	All screws except WKFC, WKFS, WKFP and WKFC-SD, WKFS-SD, WKFP-SD screws	1.5	2	3.5	4.5	6	10	27	45
	WKFC, WKFS, WKFP and WKFC-SD, WKFS-SD, WKFP-SD screws	-	-	-	-	-	10	27	45

### A.2.1 General

All blaugelb screws achieve a bending angle  $\alpha$  of at least  $45/d^{0.7} + 20$ , where d is the outer thread diameter of the screws.

The minimum penetration length of the threaded part of the screw  $l_{ef}$  is:

$$l_{ef} = \min \begin{cases} \frac{4 \cdot d}{\sin \alpha} \\ 20 \cdot d \end{cases} \quad (2.1)$$

Where

$\alpha$  angle between screw axis and grain direction [°],

d outer thread diameter of the screw [mm].

The outer thread diameter d of screws inserted in cross laminated timber is at least 6 mm. The inner thread diameter  $d_1$  of the screws shall be greater than the maximal width of the gaps in the layer of cross laminated timber.

### A.2.2 Laterally loaded screws

#### A.2.2.1 General

The outer thread diameter d is used as effective diameter of the screw in accordance with EN 1995-1-1.

The embedding strength for the screws in wood-based members or in wood-based panels shall be taken from EN 1995-1-1, unless otherwise specified in the following.

For steel-to-timber connections with WKLC screws with  $d = 5$  mm, a thick steel plate may be assumed for steel plate thickness  $t \geq 1.5$  mm.

For laterally loaded screws, the rules for multiple fastener connections in EN 1995-1-1, clause 8.3.1.1 (8) should be applied, if the timber under each fastener in a connection is not reinforced as given in Annex 4 and Annex 5.

blaugelb screws	Annex 2
Characteristic values of the load-carrying capacities	

#### A.2.2.2 Solid timber, glued laminated timber, glued solid timber and solid wood panels

The embedding strength for screws in non-pre-drilled holes in softwood arranged at an angle between screw axis and grain direction of  $0^\circ \leq \alpha \leq 90^\circ$  is:

$$f_{h,k} = \frac{0.082 \cdot \rho_k \cdot d^{-0.3}}{2.5 \cdot \cos^2 \alpha + \sin^2 \alpha} \quad [\text{N/mm}^2] \quad (2.2)$$

The embedding strength for screws in pre-drilled holes in softwood at an angle between screw axis and grain direction of  $0^\circ \leq \alpha \leq 90^\circ$  is:

$$f_{h,k} = \frac{0.082 \cdot \rho_k \cdot (1 - 0.01 \cdot d)}{2.5 \cdot \cos^2 \alpha + \sin^2 \alpha} \quad [\text{N/mm}^2] \quad (2.3)$$

Where

- $\rho_k$  characteristic density of the wood-based member [ $\text{kg/m}^3$ ],
- $d$  outer thread diameter of the screw [mm],
- $\alpha$  angle between screw axis and grain direction,  $0^\circ \leq \alpha \leq 90^\circ$ .

#### A.2.2.3 Laminated veneer lumber

The embedding strength for screws in non-pre-drilled holes in softwood LVL arranged at an angle between screw axis and grain direction,  $0^\circ \leq \alpha \leq 90^\circ$  is:

$$f_{h,k} = \frac{0.082 \cdot \rho_k \cdot d^{-0.3}}{(2.5 \cdot \cos^2 \alpha + \sin^2 \alpha)(1.5 \cdot \cos^2 \beta + \sin^2 \beta)} \quad [\text{N/mm}^2] \quad (2.4)$$

and accordingly, for screws in pre-drilled holes in softwood LVL arranged at an angle between screw axis and grain direction,  $0^\circ \leq \alpha \leq 90^\circ$ :

$$f_{h,k} = \frac{0.082 \cdot \rho_k \cdot (1 - 0.01 \cdot d)}{(2.5 \cdot \cos^2 \alpha + \sin^2 \alpha)(1.5 \cdot \cos^2 \beta + \sin^2 \beta)} \quad [\text{N/mm}^2] \quad (2.5)$$

Where

- $\rho_k$  characteristic timber density of the softwood LVL [ $\text{kg/m}^3$ ],  $\rho_k \leq 500 \text{ kg/m}^3$ ,
- $d$  outer thread diameter of the screw [mm],
- $\alpha$  angle between screw axis and grain direction ( $0^\circ \leq \alpha \leq 90^\circ$ ),
- $\beta$  angle between screw axis and the LVL's wide face ( $0^\circ \leq \beta \leq 90^\circ$ ).

#### A.2.2.4 Cross laminated timber

The embedding strengths in accordance with equations (2.2) and (2.3) may be applied for screws within single softwood layers in cross laminated timber, if the single layer is considered as a separate softwood member and the minimum spacings, end and edge distances are observed for the single layer. For inner layers, the edge distance perpendicular to the grain may be reduced to  $3 \cdot d$ .

Alternatively, the embedding strength for screws arranged in the edge surfaces parallel to the plane of cross laminated timber may be assumed according to equation (2.6) independent of the angle between screw axis and grain direction,  $0^\circ \leq \alpha \leq 90^\circ$ :

$$f_{h,k} = 20 \cdot d^{-0.5} \quad [\text{N/mm}^2] \quad (2.6)$$

unless otherwise specified in the technical specification of the cross laminated timber.

Where  $d$  is the outer thread diameter of the screws in mm.

Equation (2.6) is only valid for softwood layers. The provisions in the European Technical Assessment of the cross laminated timber apply.

blaugelb screws	Annex 2
Characteristic values of the load-carrying capacities	



The embedding strength for screws in the wide faces of cross laminated timber should be assumed as for solid timber based on the characteristic density of the outer layer. If relevant, the angle between force and grain direction of the outer layer shall be taken into account. The direction of the lateral force shall be perpendicular to the screw axis and parallel to the wide faces of the cross laminated timber.

### A.2.3 Axially loaded screws

#### A.2.3.1 Slip modulus for axially loaded screws

The axial slip modulus  $K_{ser}$  of the threaded part of a screw for the serviceability limit state per side shall be taken independent of angle  $\alpha$  to the grain as:

$$K_{ser} = 25 \cdot l_{ef} \cdot d \quad [\text{N/mm}] \quad (2.7)$$

Where

$d$  outer thread diameter of the screw [mm],

$l_{ef}$  penetration length of the threaded part of the screw in the wood-based member [mm].

#### A.2.3.2 Axial withdrawal capacity – Characteristic withdrawal parameter

The characteristic withdrawal capacity for blaugelb screws in solid timber, glued laminated timber, glued solid timber, cross laminated timber or laminated veneer lumber members (softwood) or solid wood panels at an angle of  $0^\circ \leq \alpha \leq 90^\circ$  to the grain shall be calculated as:

$$F_{ax,\alpha,Rk} = \frac{n_{ef} \cdot k_{ax} \cdot f_{ax,k} \cdot d \cdot l_{ef}}{k_\beta} \cdot \left( \frac{\rho_k}{\rho_a} \right)^{0.8} \quad (2.8)$$

Where

$F_{ax,\alpha,Rk}$  characteristic withdrawal capacity of a screw group at an angle  $\alpha$  to the grain [N],

$n_{ef}$  effective number of screws in accordance with EN 1995-1-1, clause 8.7.2 (8),

For inclined screws in laterally loaded connections with an angle between shear plane and screw axis  $30^\circ \leq \alpha \leq 60^\circ$ :

$$n_{ef} = \max \left\{ n^{0.9}; 0.9 \cdot n \right\} \quad (2.9)$$

For screws as compression reinforcement or inclined screws as fasteners in mechanically jointed beams or columns or for the fixing of thermal insulation material,  $n_{ef} = n$ .

$n$  number of screws acting together in a connection,

For inclined screws is  $n$  the number of crossed pairs of screws.

$k_{ax}$  factor, taking into account the angle  $\alpha$  between screw axis and grain direction

$$k_{ax} = 1.0 \quad \text{for } 45^\circ \leq \alpha \leq 90^\circ$$

$$k_{ax} = a + \frac{b \cdot \alpha}{45^\circ} \quad \text{for } 0^\circ \leq \alpha < 45^\circ \quad (2.10)$$

$a = 0.5$  for LVL

$a = 0.3$  for solid timber, glued laminated timber, glued solid timber, cross laminated timber and solid wood panels

$b = 0.5$  for LVL

$b = 0.7$  for solid timber, glued laminated timber, glued solid timber, cross laminated timber and solid wood panels

$k_\beta$   $k_\beta = 1.0$  for solid timber, glued solid timber, glued laminated timber, cross laminated timber and solid wood panels

$$k_\beta = 1.5 \cdot \cos^2 \beta + \sin^2 \beta \quad \text{for LVL}$$

blaugelb screws

Characteristic values of the load-carrying capacities

Annex 2

- $\alpha$  angle between grain and screw axis ( $0^\circ \leq \alpha \leq 90^\circ$ ),
- $\beta$  angle between screw axis and the LVL's wide face ( $0^\circ \leq \beta \leq 90^\circ$ ),
- $f_{ax,k}$  characteristic withdrawal parameter for solid timber, glued laminated timber, glued solid timber, cross laminated timber, solid wood panels at an angle  $\alpha = 90^\circ$  based on a characteristic density  $\rho_a$  of  $350 \text{ kg/m}^3$ ,  
 $f_{ax,k} = 13 \text{ N/mm}^2$  for  $d \leq 4.5 \text{ mm}$   
 $f_{ax,k} = 12 \text{ N/mm}^2$  for  $5 \text{ mm} \leq d \leq 8 \text{ mm}$   
 $f_{ax,k} = 11 \text{ N/mm}^2$  for  $d = 10 \text{ mm}$   
characteristic withdrawal parameter for LVL at an angle  $\alpha = 90^\circ$  based on a characteristic density of  $480 \text{ kg/m}^3$ ,  
 $f_{ax,k} = 15 \text{ N/mm}^2$  for  $d \leq 5 \text{ mm}$   
 $f_{ax,k} = 13 \text{ N/mm}^2$  for  $6 \text{ mm} \leq d \leq 10 \text{ mm}$
- $d$  outer thread diameter of the threaded part of the screw [mm],
- $l_{ef}$  point side penetration length of the threaded part of the screw in the wood-based member [mm],
- $\rho_k$  characteristic density of the wood-based member [ $\text{kg/m}^3$ ], for LVL  $\rho_k \leq 500 \text{ kg/m}^3$ ,
- $\rho_a$  reference density for  $f_{ax,k}$ , for solid timber, glued laminated timber, glued solid timber, cross laminated timber, solid wood panels  $\rho_a = 350 \text{ kg/m}^3$  and for LVL  $\rho_a = 480 \text{ kg/m}^3$ .

For screws penetrating more than one layer of cross laminated timber, the different layers may be taken into account proportionally. In the narrow faces of the cross laminated timber the screws shall be fully inserted in one layer of cross laminated timber.

Alternatively, the axial withdrawal capacity for screws arranged parallel to the plane of cross laminated timber, independent of the angle between screw axis and grain direction,  $0^\circ \leq \alpha \leq 90^\circ$ , may be calculated as:

$$F_{ax,Rk} = 20 \cdot d^{0.8} \cdot l_{ef}^{0.9} \quad [\text{N}] \quad (2.11)$$

Where

- $d$  outer thread diameter of the screw [mm],
- $l_{ef}$  point side penetration length of the threaded part of the screw in the wood-based member [mm].

blaugelb screws	Annex 2
Characteristic values of the load-carrying capacities	

### A.2.3.3 Head pull-through capacity – Characteristic head pull-through parameter

The characteristic value of the head pull-through parameter for blaugelb screws for a characteristic density of 350 kg/m<sup>3</sup> of the softwood timber member, of 480 kg/m<sup>3</sup> of softwood LVL member and for wood-based panels like

- Plywood in accordance with EN 636 and EN 13986,
- Oriented strand boards (OSB) in accordance with EN 300 and EN 13986,
- Particleboards in accordance with EN 312 and EN 13986,
- Fibreboards in accordance with EN 622-2, EN 622-3 and EN 13986,
- Cement-bonded particleboards in accordance with EN 634-2 and EN 13986,
- Solid wood panels (SWP) in accordance with EN 13353 and EN 13986.

with a thickness of more than 20 mm is

$$f_{\text{head,k}} = 55 \cdot d_h^{-0,5} \quad [\text{N/mm}^2] \quad (2.12)$$

Where

$d_h$  head diameter [mm].

For wood-based panels a maximum characteristic density of 380 kg/m<sup>3</sup> and for LVL a maximum characteristic density of 500 kg/m<sup>3</sup> shall be used in equation (8.40b) of EN 1995-1-1.

The head diameter  $d_h$  shall be equal or greater than  $1.8 \cdot d_s$ , where  $d_s$  is the smooth shank or for fully threaded screws the inner thread diameter. Otherwise the characteristic head pull-through capacity in equation (8.40b) of EN 1995-1-1 is:  $F_{ax,\alpha,Rk} = 0$  for all wood-based materials.

For wood-based panels with a thickness  $12 \text{ mm} \leq t \leq 20 \text{ mm}$  the characteristic value of the head pull-through parameter for blaugelb screws is:

$$f_{\text{head,k}} = 8.0 \text{ N/mm}^2.$$

For wood-based panels with a thickness of less than 12 mm the characteristic head pull-through capacity for blaugelb screws shall be based on a characteristic value of the head pull-through parameter of 8.0 N/mm<sup>2</sup>. The head pull-through capacity shall be limited to 400 N. A minimum thickness of the wood-based panels of  $1.2 \cdot d$ , where  $d$  is the outer thread diameter, and the values in Table A.2.2 shall be complied.

Outer head or washer diameter  $d_h \geq 32 \text{ mm}$  should not be considered.

Table A.2.2 Minimum thickness of wood-based panels

Wood-based panel	Minimum thickness [mm]
Plywood	6
Fibreboards (hardboards and medium boards)	6
Oriented strand boards (OSB)	8
Particleboards	8
Cement-bonded particleboards	8
Solid wood panels (SWP)	12

In steel-to-timber connections the head pull-through capacity is not governing.

blaugelb screws	Annex 2
Characteristic values of load-bearing capacities	

#### A.2.3.4 Compressive capacity of blaugelb screws – Characteristic yield strength

The design axial compression capacity  $F_{ax,Rd}$  of WKFS, WKFC, WKFP and WKFS-SD, WKFC-SD, WKFP-SD screws embedded in solid timber, glued solid timber or glued laminated timber made from softwood with an angle  $\alpha$  between screw axis and grain direction of  $30^\circ \leq \alpha \leq 90^\circ$  is the minimum of the axial resistance against pushing-in and the buckling resistance of the screw.

$$F_{ax,Rd} = \min \{ \kappa_{ax} \cdot f_{ax,d} \cdot d \cdot l_{ef} ; \kappa_c \cdot N_{pl,d} \} \quad (2.13)$$

$\kappa_{ax}$  factor, taking into account the angle  $\alpha$  between screw axis and grain direction as given in clause A.2.3.2,

$f_{ax,d}$  design value of the axial withdrawal parameter of the threaded part of the screw [N/mm<sup>2</sup>],

$d$  outer thread diameter of the screw [mm],

$l_{ef}$  penetration length of the threaded part of the screw in the timber member [mm].

$$\kappa_c = 1 \quad \text{for } \bar{\lambda}_k \leq 0,2 \quad (2.14)$$

$$\kappa_c = \frac{1}{k + \sqrt{k^2 - \bar{\lambda}_k^2}} \quad \text{for } \bar{\lambda}_k > 0,2 \quad (2.15)$$

$$k = 0,5 \cdot \left[ 1 + 0,49 \cdot (\bar{\lambda}_k - 0,2) + \bar{\lambda}_k^2 \right] \quad (2.16)$$

and a relative slenderness ratio  $\bar{\lambda}_k = \sqrt{\frac{N_{pl,k}}{N_{ki,k}}}$  (2.17)

$N_{pl,k}$  characteristic plastic normal force related to the net cross section of the inner thread diameter:

$$N_{pl,k} = \pi \cdot \frac{d_1^2}{4} \cdot f_{y,k} \quad (2.18)$$

$f_{y,k}$  characteristic yield strength,  $f_{y,k} = 1000$  N/mm<sup>2</sup> for WKFS, WKFC, WKFP and WKFS-SD, WKFC-SD, WKFP-SD screws,

$d_1$  inner thread diameter of the screw [mm],

$$N_{pl,d} = \frac{N_{pl,k}}{\gamma_{M1}} \quad (2.19)$$

$\gamma_{M1}$  partial factor in accordance with EN 1993-1-1<sup>11</sup>.

characteristic ideal elastic buckling load:

$$N_{ki,k} = \sqrt{c_h \cdot E_s \cdot I_s} \quad [\text{N}] \quad (2.20)$$

elastic foundation of the screw:

$$c_h = (0,19 + 0,012 \cdot d) \cdot \rho_k \cdot \left( \frac{90^\circ + \alpha}{180^\circ} \right) \quad [\text{N/mm}^2] \quad (2.21)$$

$\rho_k$  characteristic density of the wood-based member [kg/m<sup>3</sup>],

$\alpha$  angle between screw axis and grain direction,  $30^\circ \leq \alpha \leq 90^\circ$ .

modulus of elasticity:  $E_s = 210,000$  N/mm<sup>2</sup>, second moment of area:  $I_s = \frac{\pi \cdot d_1^4}{64}$  [mm<sup>4</sup>]. (2.22)

<sup>11</sup> EN 1993-1-1:2005/AC:2009 Eurocode 3: Design of steel structures – Part 1-1: General rules and rules for buildings +A1:2014

blaugelb screws	Annex 2
Compressive capacity – Characteristic yield strength	

## A.2.4 Spacings, end and edge distances of the screws and minimum thickness of the wood-based material

### A.2.4.1 Laterally or laterally *and* axially loaded screws

#### Screws in pre-drilled holes

For blaugelb screws in pre-drilled holes the minimum spacings, end and edge distances are given in EN 1995-1-1, clause 8.3.1.2 and Table 8.2 as for nails in pre-drilled holes. Here, the outer thread diameter  $d$  shall be considered.

Minimum thickness for structural wood-based members made of solid timber, glued laminated timber, glued solid timber, laminated veneer lumber and cross laminated timber is  $t = 24$  mm for screws with outer thread diameter  $d < 8$  mm,  $t = 30$  mm for screws with outer thread diameter  $d = 8$  mm and  $t = 40$  mm for screws with outer thread diameter  $d = 10$  mm.

#### Screws in non pre-drilled holes

For blaugelb screws in non-predrilled holes the minimum spacings, end and edge distances and the minimum member thickness are given in EN 1995-1-1, clause 8.3.1.2 and Table 8.2 as for nails in non-predrilled holes. Here, the outer thread diameter  $d$  shall be considered.

For Douglas fir members minimum spacings and distances parallel to the grain shall be increased by 50 %.

Minimum distances from loaded or unloaded ends parallel to the grain shall be at least  $15 \cdot d$  for screws with outer thread diameter  $d > 8$  mm and timber thickness  $t < 5 \cdot d$ .

Minimum thickness for structural wood-based members made from solid timber, glued laminated timber, glued solid timber, laminated veneer lumber and cross laminated timber is  $t = 24$  mm for screws with outer thread diameter  $d < 8$  mm,  $t = 30$  mm for screws with outer thread diameter  $d = 8$  mm and  $t = 40$  mm for screws with outer thread diameter  $d = 10$  mm, if the spacing parallel to grain and the end distance are at least  $25 \cdot d$ .

Minimum distances from the unloaded edge perpendicular to the grain may be reduced to  $3 \cdot d$  also for timber thickness  $t < 5 \cdot d$ , if the spacing parallel to the grain and the end distance is at least  $25 \cdot d$ .

### A.2.4.2 Only axially loaded screws

For blaugelb screws the minimum spacings, end and edge distances and the minimum member thickness are given in EN 1995-1-1, clause 8.3.1.2 and Table 8.2 as for nails in non-predrilled holes and clause 8.7.2, Table 8.6.

### A.2.4.3 Cross laminated timber

The minimum requirements for spacing, end and edge distances of screws in the wide or narrow faces of cross laminated timber are summarised in Table A.2.3. The definition of spacings, end and edge distance is shown in Figure A.2.1 and Figure A.2.2. The minimum spacings, end and edge distances in the narrow faces are independent of the angle between screw axis and grain direction. They shall be used based on the following conditions:

- Minimum thickness of the cross laminated timber:  $10 \cdot d$
- Minimum penetration depth in the narrow faces of the cross laminated timber:  $10 \cdot d$

For load components perpendicular to the wide faces (see Figure A.2.2 right) the tensile stresses perpendicular to the grain should be transferred by reinforcing screws.

Table A.2.3 Minimum spacings, end and edge distances of screws in the wide or narrow faces of cross laminated timber

	$a_1$	$a_{3,t}$	$a_{3,c}$	$a_2$	$a_{4,t}$	$a_{4,c}$
Wide faces (see Figure A.2.1)	$4 \cdot d$	$6 \cdot d$	$6 \cdot d$	$2.5 \cdot d$	$6 \cdot d$	$2.5 \cdot d$
Narrow faces (see Figure A.2.2)	$10 \cdot d$	$12 \cdot d$	$7 \cdot d$	$4 \cdot d$	$6 \cdot d$	$3 \cdot d$

blaugelb screws

Spacings, end and edge distances and minimum thickness

Annex 2

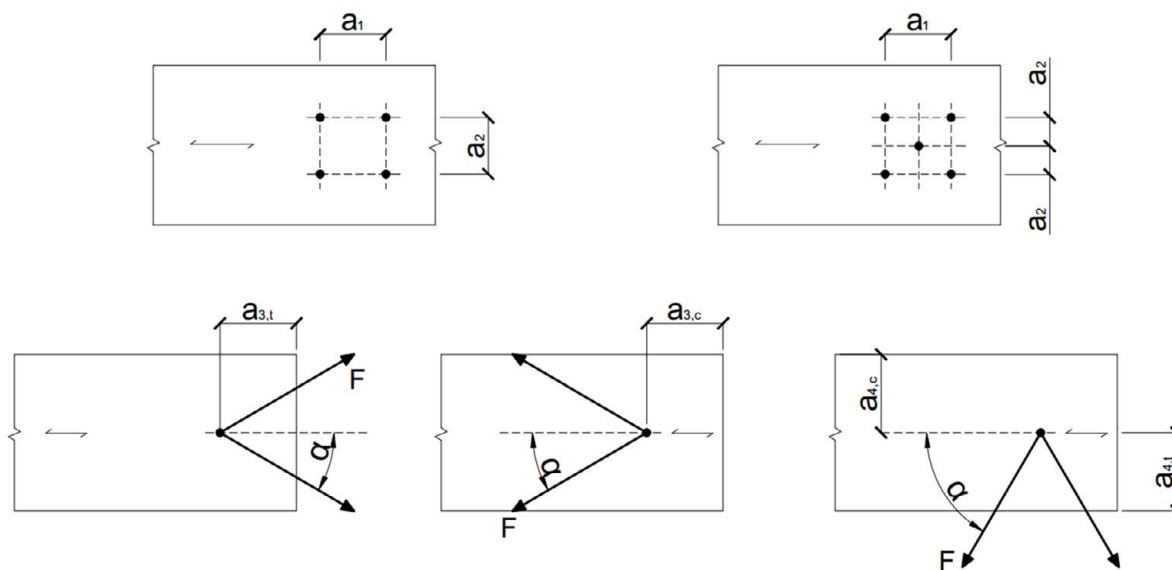

Figure A.2.1 Definition of spacings, end and edge distances in the wide faces of the cross laminated timber.

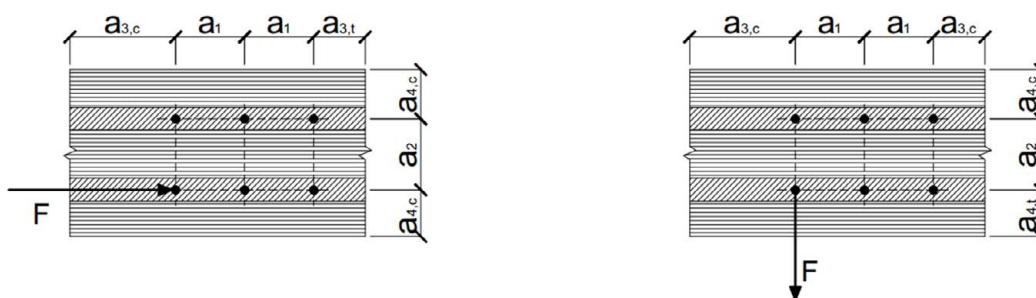

Figure A.2.2 Definition of spacings, end and edge distances in the narrow faces of the cross laminated timber. For screws in the narrow faces,  $a_1$  and  $a_3$  are parallel to the CLT wide face,  $a_2$  and  $a_4$  perpendicular to CLT wide face.

blaugelb screws

Spacings, end and edge distances

Annex 2

### A.2.5 Insertion moment

The ratio between the characteristic torsional strength  $f_{tor,k}$  and the mean value of insertion moment  $R_{tor,mean}$  fulfills the requirement for all blaugelb screws.

### A.2.6 Durability **against corrosion**

The blaugelb screws and washers may have the coatings as given in Table A.2.4.

Table A.2.4 Coatings of the blaugelb screws

Coating	Minimum thickness of the coating [ $\mu\text{m}$ ]
electrogalvanised	5
non-electrolytically applied zinc flake coating	8

blaugelb screws	Annex 2
Insertion moment and durability against corrosion	

## Annex 3 Compression reinforcement perpendicular to the grain (informative)

### A.3.1 General

WKFS, WKFC, WKFP and WKFS-SD, WKFC-SD, WKFP-SD screws may be used for compression reinforcement perpendicular to the grain. The provisions are valid for reinforcing timber members made from solid timber, glued solid timber or glued laminated timber made from softwood.

The compression force shall be distributed evenly to the screws used as compression reinforcement.

The screws are driven into the timber member perpendicular to the contact surface under an angle between the screw axis and the grain direction of 45° to 90°. The screw heads shall be flush with the timber surface.

Compressive reinforcing screws for wood-based panels and timber members made of hardwood are not covered by this European Technical Assessment.

### A.3.2 Design

For the design of reinforced contact areas the following conditions shall be met independently of the angle between the screw axis and the grain direction.

The design resistance of a reinforced contact area is:

$$R_{90,d} = \min \left\{ \begin{array}{l} k_{c,90} \cdot B \cdot l_{ef,1} \cdot f_{c,90,d} + n \cdot \min\{R_{ax,d}; \kappa_c \cdot N_{pl,d}\} \\ B \cdot l_{ef,2} \cdot f_{c,90,d} \end{array} \right. \quad (3.1)$$

Where

$k_{c,90}$  parameter in accordance with EN 1995-1-1, clause 6.1.5,

$B$  bearing width [mm],

$l_{ef,1}$  effective contact length in accordance with EN 1995-1-1, clause 6.1.5 [mm],

$f_{c,90,d}$  design compressive strength perpendicular to the grain [N/mm<sup>2</sup>],

$n$  number of reinforcing screws,  $n = n_0 \cdot n_{90}$ ,

$n_0$  number of reinforcing screws arranged in a row parallel to the grain,

$n_{90}$  number of reinforcing screws arranged in a row perpendicular to the grain,

$$R_{ax,d} = f_{ax,d} \cdot d \cdot l_{ef} \quad [N] \quad (3.2)$$

$f_{ax,d}$  design value of the axial withdrawal parameter of the threaded part of the screw [N/mm<sup>2</sup>],

$d$  outer thread diameter of the screw [mm],

$\kappa_c$  in accordance with Annex A.2.3.4,

$N_{pl,d}$  in accordance with Annex A.2.3.4 [N],

$l_{ef,2}$  effective contact length in the plane of the screw tips (see Figure 3.1) [mm],

$$l_{ef,2} = \{l_{ef} + (n_0 - 1) \cdot a_1 + \min(l_{ef}; a_{1,CG})\} \text{ for end supports (see Figure 3.1 left)}$$

$$l_{ef,2} = \{2 \cdot l_{ef} + (n_0 - 1) \cdot a_1\} \text{ for intermediate supports (see Figure 3.1 right)}$$

$l_{ef}$  penetration length of the threaded part of the screw in the timber member [mm],

$a_1$  spacing  $a_1$  in a plane parallel to grain, see chapter A.2.4.2 [mm],

$a_{1,CG}$  end distance of the centre of gravity of the threaded part in the timber member, see chapter A.2.4.2 [mm].

blaugelb screws

Compression reinforcement perpendicular to the grain

Annex 3



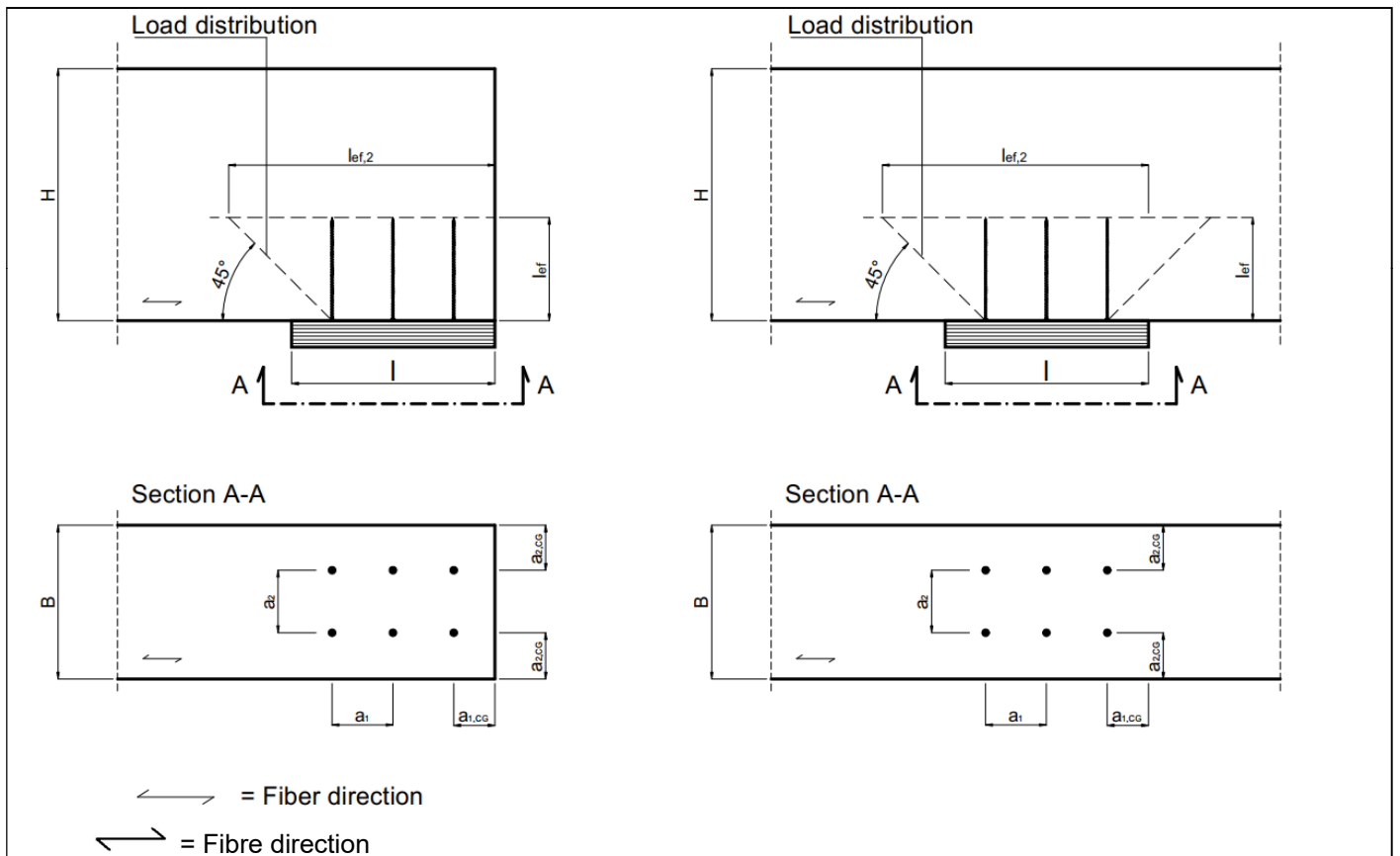

Figure A.3.1 Reinforced end support (left) and reinforced intermediate support (right)

blaugelb screws	Annex 3
Compression reinforcement perpendicular to the grain	

## Annex 4 Tensile reinforcement perpendicular to grain (informative)

### A.4.1 General

Only WKFS, WKFC, WKFP and WKFS-SD, WKFC-SD, WKFP-SD screws with full thread shall be used for tensile reinforcement perpendicular to the grain.

The screws are driven into the timber member perpendicular to the contact surface under an angle between the screw axis and the grain direction of 90°.

The provisions regarding tensile reinforcement perpendicular to the grain are valid for the following timber members:

- Solid timber made of softwood,
- Glued laminated timber made of softwood,
- Glued solid timber made of softwood,
- Laminated veneer lumber made of softwood.

As examples connection forces at an angle to the grain and notched beam supports and connections with laterally loaded dowel-type fasteners are given in the following.

Note: For example, in Germany the provisions of DIN EN 1995-1-1/NA, NCI NA.6.8 and amendments could be taken into account.

A minimum of two screws shall be used for tensile reinforcement perpendicular to the grain. Only one screw may be used when the minimum penetration depth of the screws below and above the potential crack is 20·d, where d is the outer thread diameter of the screw.

### A.4.2 Design

#### A.4.2.1 Connection forces at an angle to the grain

The axial capacity of a reinforcement of a timber member loaded by a connection force perpendicular to the grain shall fulfil the following condition:

$$\frac{[1 - 3 \cdot \alpha^2 + 2 \cdot \alpha^3] \cdot F_{90,d}}{F_{ax,Rd}} \leq 1 \quad (4.1)$$

Where

$F_{90,d}$  design value of the force component perpendicular to the grain [N],

$\alpha = a/h$

a see Figure A.4.1 [mm],

h member depth [mm],

$F_{ax,Rd} = \min \{ f_{ax,d} \cdot d \cdot \ell_{ef}; F_{t,Rd} \}$

$f_{ax,d}$  design value of the axial withdrawal parameter of the threaded part of the screw [N/mm<sup>2</sup>],

d outer thread diameter of the screw [mm],

$\ell_{ef}$  smaller value of the penetration depth below or above the potential crack [mm],

$F_{t,Rd}$  design value of the tensile resistance of the screw =  $f_{tens,d}$

Outside the connection only one screw each in longitudinal direction of the beam shall be taken into account.

blaugelb screws	Annex 4
Tensile reinforcement perpendicular to the grain	

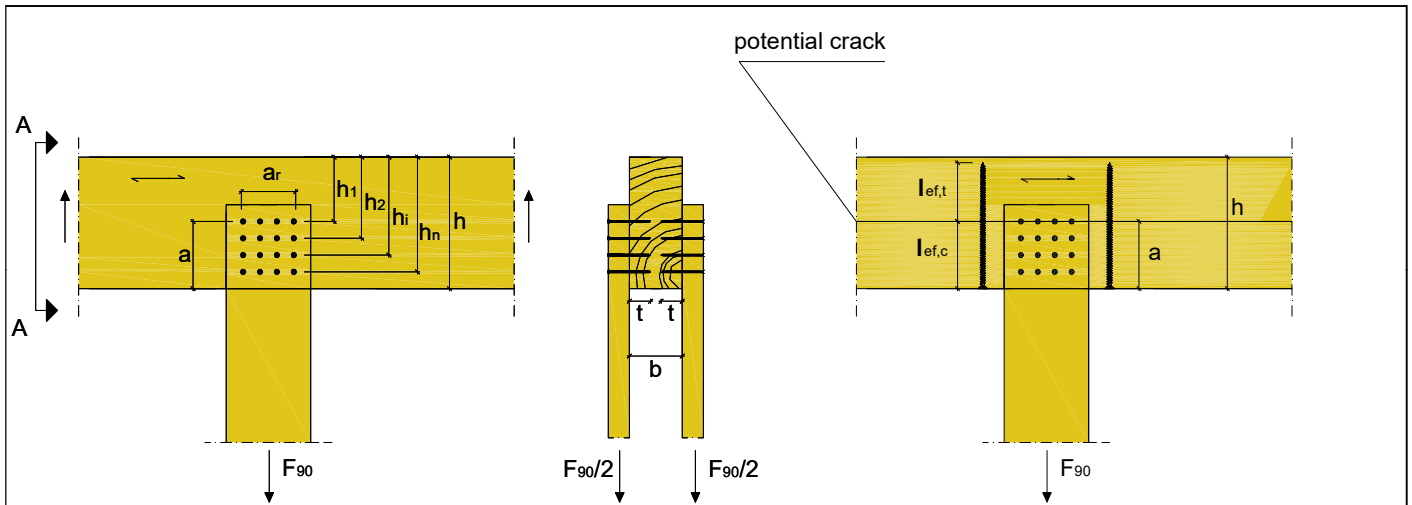

Figure A.4.1 Example for tensile reinforcement of a connection force perpendicular to the grain

#### A.4.2.2 Notched beam supports

The axial capacity of a reinforcement of a notched beam support shall fulfil the following condition:

$$\frac{1,3 \cdot V_d \cdot \left[ 3 \cdot (1-\alpha)^2 - 2 \cdot (1-\alpha)^3 \right]}{F_{ax,Rd}} \leq 1 \quad (4.2)$$

Where

$V_d$  design value of the shear force [N],

$$\alpha = h_e/h$$

$h_e$  see Figure A.4.2 [mm],

$h$  member depth [mm],

$$F_{ax,Rd} = \min \{ f_{ax,d} \cdot d \cdot l_{ef}; F_{t,Rd} \}$$

$f_{ax,d}$  design value of the axial withdrawal parameter of the threaded part of the screw [N/mm<sup>2</sup>],

$d$  outer thread diameter of the screw [mm],

$l_{ef}$  smaller value of the penetration depth below or above the potential crack, the total minimum penetration depth of the screw shall be  $2 \cdot l_{ef}$  [mm],

$F_{t,Rd}$  design value of the tensile resistance of the screws =  $f_{tens,d}$ ,

Only one screw in longitudinal direction of the beam shall be taken into account.

blaugelb screws	Annex 4
Tensile reinforcement perpendicular to the grain	

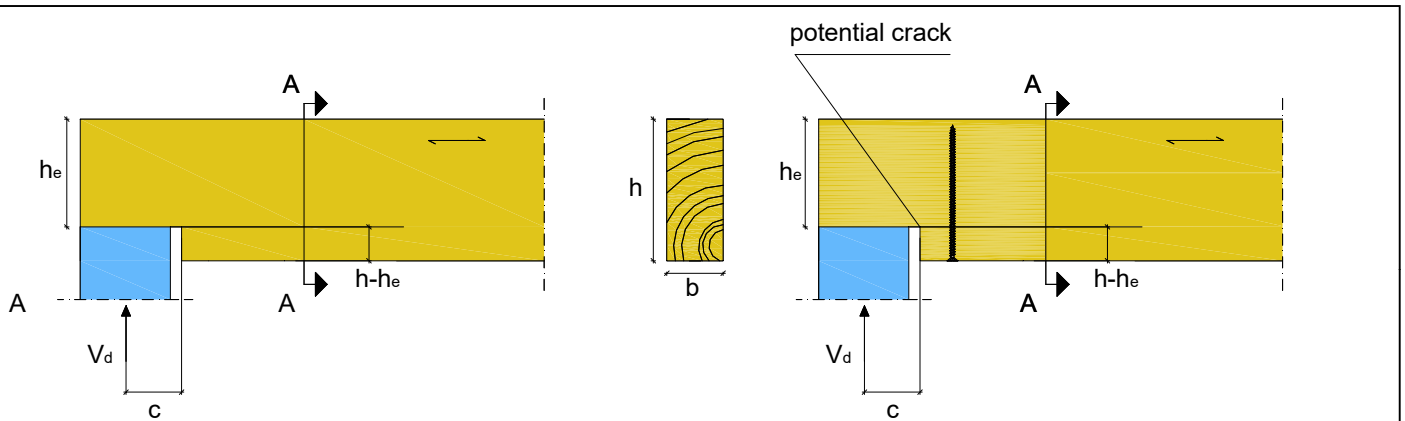

Figure A.4.2 Example for tensile reinforcement of a notched beam support

### A.4.2.3 Connections with laterally loaded dowel-type fasteners

The axial capacity of a reinforcement of a steel-to-timber or timber-to-timber connection with laterally loaded dowel-type fasteners loaded by a connection force parallel to the grain shall fulfil the following condition:

$$\frac{0.3 \cdot F_{v,0,Ed}}{F_{ax,Rd}} \leq 1 \quad (4.3)$$

Where

$F_{v,0,Ed}$  design value of the fastener force component parallel to the grain [N],

For outer timber members  $F_{v,0,Ed}$  is the load per fastener per shear plane, for inner timber members  $F_{v,0,Ed}$  is the accumulated load per fastener for the two shear planes.

$F_{ax,Rd}$  minimum of the design values of the withdrawal capacity and the tensile capacity of the reinforcing full thread screws where  $l_{ef}$  is the smaller value of the penetration depth at the screw tip or head (see Figure A.4.3).

If the timber under each fastener in a connection is reinforced, the effective number  $n_{ef}$  in accordance with EN 1995-1-1, equation (8.34) may be taken as  $n_{ef} = n$ .

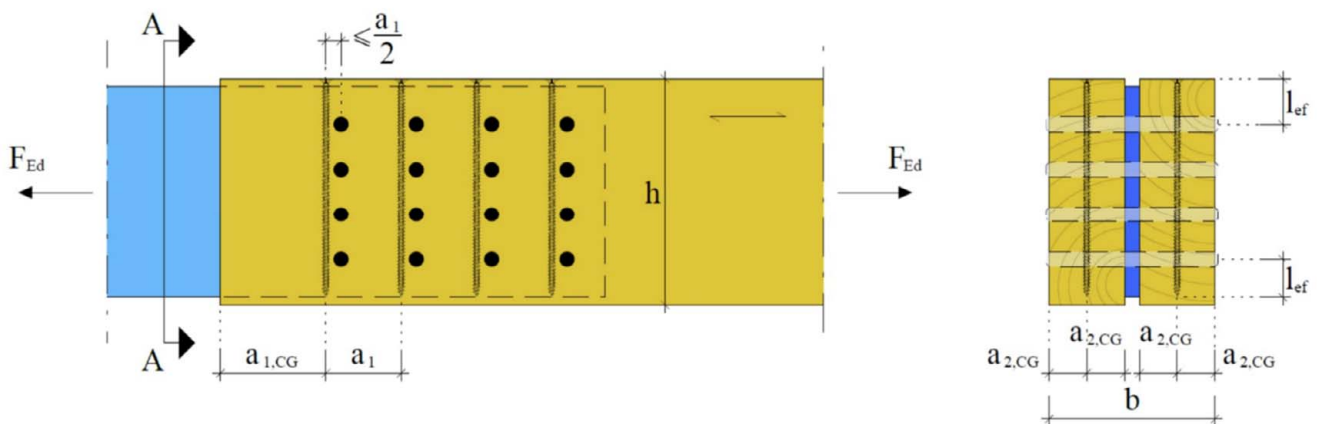

Figure A.4.3 Dowelled steel-to-timber connection with outer timber members and reinforcement

blaugelb screws	Annex 4
Tensile reinforcement perpendicular to the grain	

## Annex 5 Shear reinforcement (informative)

### A.5.1 General

Only WKFS, WKFC, WKFP and WKFS-SD, WKFC-SD, WKFP-SD screws with full thread and with  $d = 8$  mm may be used for shear reinforcement of timber members. The provisions are valid for straight beams with constant rectangular cross section.

The screws shall be driven into the timber member under an angle between the screw axis and the grain direction of  $45^\circ$ .

The provisions regarding shear reinforcement are valid for the following timber members:

- Solid timber made of softwood,
- Glued laminated timber made of softwood,
- Glued solid timber made of softwood.

A minimum number of four screws shall be arranged in a line parallel to the grain as shear reinforcement. The spacing between the screws in a line parallel to the grain shall not exceed the depth  $h$  of the timber member.

For spacings, end and edge distances of the screws the provisions in Annex A.2.4 apply.

If the screws are arranged in one line parallel to the grain, it shall be done centrally in relation to the beam width.

Outside reinforced areas the shear design shall fulfil the conditions for unreinforced timber members.

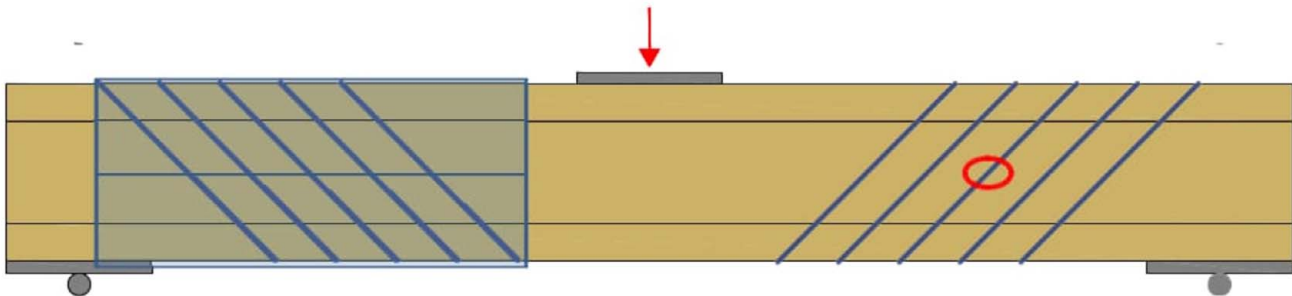

Figure A.5.1 Principle of a shear reinforced beam using screws; marked area is reinforced.

### A.5.2 Design

The provisions are valid for concentrated and linear loads.

For shear in reinforced areas of timber members specified in Annex A.5.1 with a stress component parallel to the grain, the following expression shall be satisfied:

$$\tau_d \leq f_{v,mod,d} = \frac{f_{v,d} \cdot k_\tau}{\eta_H} \quad (5.1)$$

Where

$\tau_d$  design shear stress [N/mm<sup>2</sup>],

$f_{v,d}$  design shear strength [N/mm<sup>2</sup>],

$$k_\tau = 1 - 0.46 \cdot \sigma_{90,d} - 0.052 \cdot \sigma_{90,d}^2 \quad [\text{N/mm}^2] \quad (5.2)$$

$\sigma_{90,d}$  design stress perpendicular to the grain (negative value for compression) [N/mm<sup>2</sup>],

$$\sigma_{90,d} = \frac{F_{ax,d}}{\sqrt{2} \cdot b \cdot a_1} \quad (5.3)$$

$b$  width of the timber member [mm],

$a_1$  screw spacing parallel to grain, screws arranged in one row,  $a_1 < h$  [mm],

blaugelb screws	Annex 5
Shear reinforcement	

$$F_{ax,d} \quad F_{ax,d} = \frac{\sqrt{2} \cdot (1 - \eta_H) \cdot V_d \cdot a_1}{h} \quad [\text{N/mm}^2] \quad (5.4)$$

$$\eta_H \quad \eta_H = \frac{G \cdot b \cdot 2 \cdot \sqrt{2} \left( \frac{6}{\pi \cdot d \cdot h \cdot k_{ax}} + \frac{a_1}{E \cdot A_S} \right)}{1 + G \cdot b \cdot 2 \cdot \sqrt{2} \left( \frac{6}{\pi \cdot d \cdot h \cdot k_{ax}} + \frac{a_1}{E \cdot A_S} \right)} \quad (5.5)$$

$V_d$  design shear force [N],

$d$  outer thread diameter of the screw [mm],

$h$  depth of the timber member [mm],

$G$  mean value of shear modulus [N/mm<sup>2</sup>],

$k_{ax}$  connection stiffness between screw and timber member,

$k_{ax} = 12.5 \text{ N/mm}^3$  for fully threaded blaugelb screws with  $d = 8 \text{ mm}$ ,

$E \cdot A_S$  axial stiffness of one screw,

$$E \cdot A_S = \frac{E \cdot \pi \cdot d_1^2}{4} \quad (5.6)$$

$E$  modulus of elasticity,  $E = 210,000 \text{ N/mm}^2$ ,

$d_1$  inner thread diameter of the screw [mm],

The axial capacity of the blaugelb screw shall fulfil the following condition:

$$\frac{F_{ax,d}}{F_{ax,Rd}} \leq 1 \quad (5.7)$$

Where

$$F_{ax,Rd} = \min \left\{ f_{ax,d} \cdot d \cdot l_{ef}; f_{tens,d} \right\}$$

$f_{ax,d}$  design value of the axial withdrawal parameter of the threaded part of the screw [N/mm<sup>2</sup>],

$l_{ef}$  effective penetration length [mm],

The effective penetration length is 50 percent of the threaded part length of the screw in the timber member.

$f_{tens,d}$  design tensile strength of the screw [N].

blaugelb screws	Annex 5
Shear reinforcement	

## Annex 6 Fastening of thermal insulation material on top of rafters (informative)

### A.6.1 General

For the fixing of thermal insulation material on top of rafters or on wood-based members in vertical façades blaugelb screws with an outer thread diameter of at least 6 mm may be used. In the following, the meaning of the word rafter includes wood-based members with inclinations between 0° and 90°.

The thickness of the thermal insulation material is up to 400 mm. The thermal insulation material is applicable as insulation on top of rafters or on wood-based members in vertical façades.

The counter battens are from solid timber in accordance with EN 14081-1. The minimum thickness  $t$  and the minimum width  $b$  of the counter battens are given in Table A.6.1:

Table A.6.1 Minimum thickness and minimum width of the counter battens

Outer thread diameter $d$ [mm]	Minimum thickness $t$ [mm]	Minimum width $b$ [mm]
6 and 8	30	50
10	40	60

The minimum width of the rafters is 60 mm.

The spacing between screws  $e_{scr}$  is not more than 1.75 m.

Friction forces shall not be considered for the design of the characteristic axial withdrawal capacity of the screws.

The anchorage of wind suction forces shall be considered for design. Screws perpendicular to the grain of the rafter may be arranged where required.

### A.6.2 Parallel inclined screws and thermal insulation material in compression

#### A.6.2.1 Mechanical model

The system of rafter, thermal insulation material on top of rafter and counter battens parallel to the rafter can be considered as a beam on elastic foundation. The counter batten represents the beam, and the thermal insulation material on top of the rafter the elastic foundation. The minimum compression stress of the thermal insulation material at 10 % deformation, measured in accordance with EN 826<sup>12</sup>, shall be  $\sigma_{10\%} = 0.05 \text{ N/mm}^2$ . The counter batten is loaded perpendicular to the axis by point loads  $F_b$  transferred by regularly spaced battens. Further point loads  $F_s$  are caused by the shear load of the roof due to dead and snow load, which are transferred from the screw heads into the counter battens.

<sup>12</sup> EN 826:2013 Thermal insulating products for building applications – Determination of compression behaviour

blaugelb screws	Annex 6
Fastening of thermal insulation material on top of rafters	

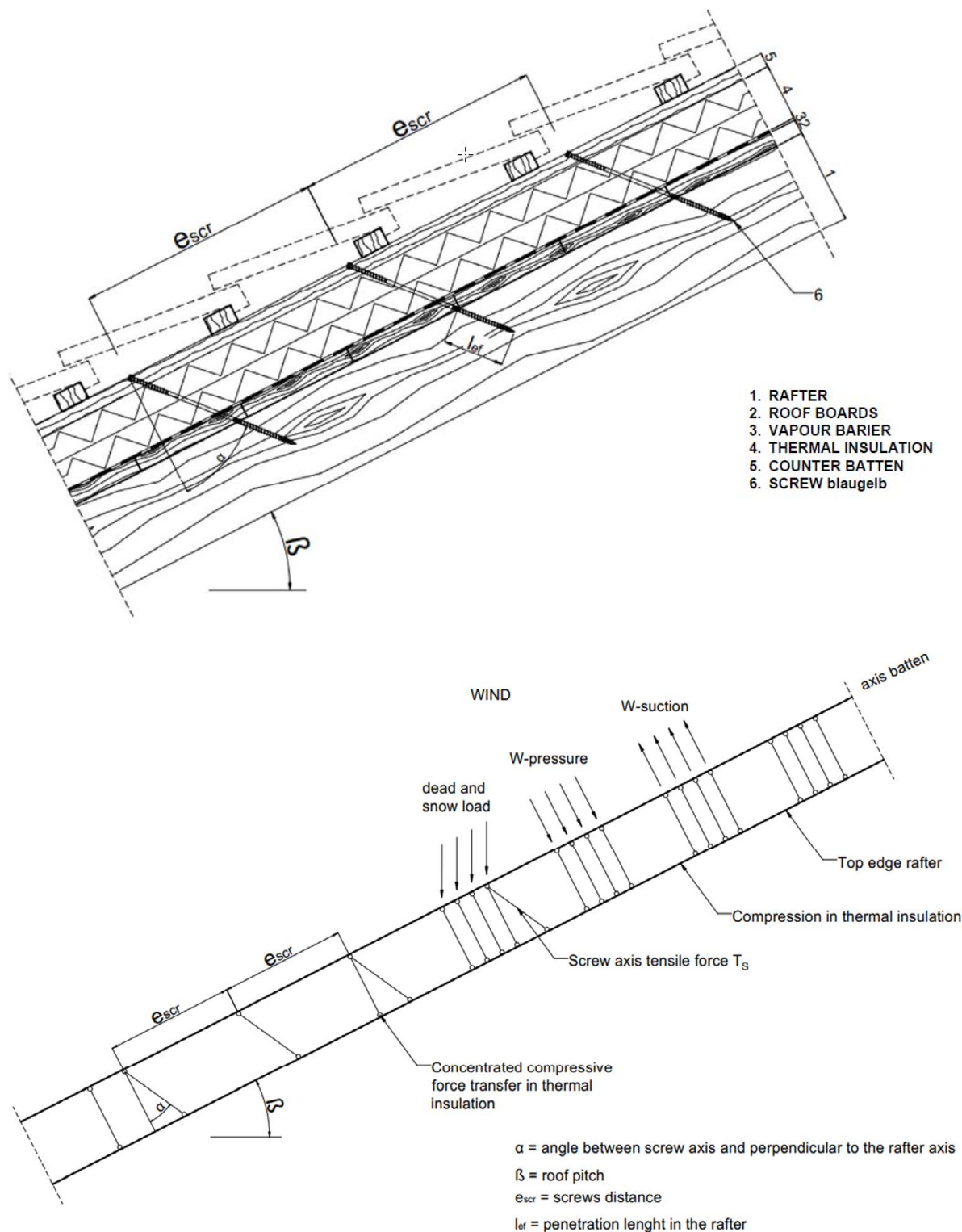

Figure A.6.1 Fastening of the thermal insulation material on top of rafters – Structural system

blaugelb screws	Annex 6
Fastening of thermal insulation material on top of rafters	



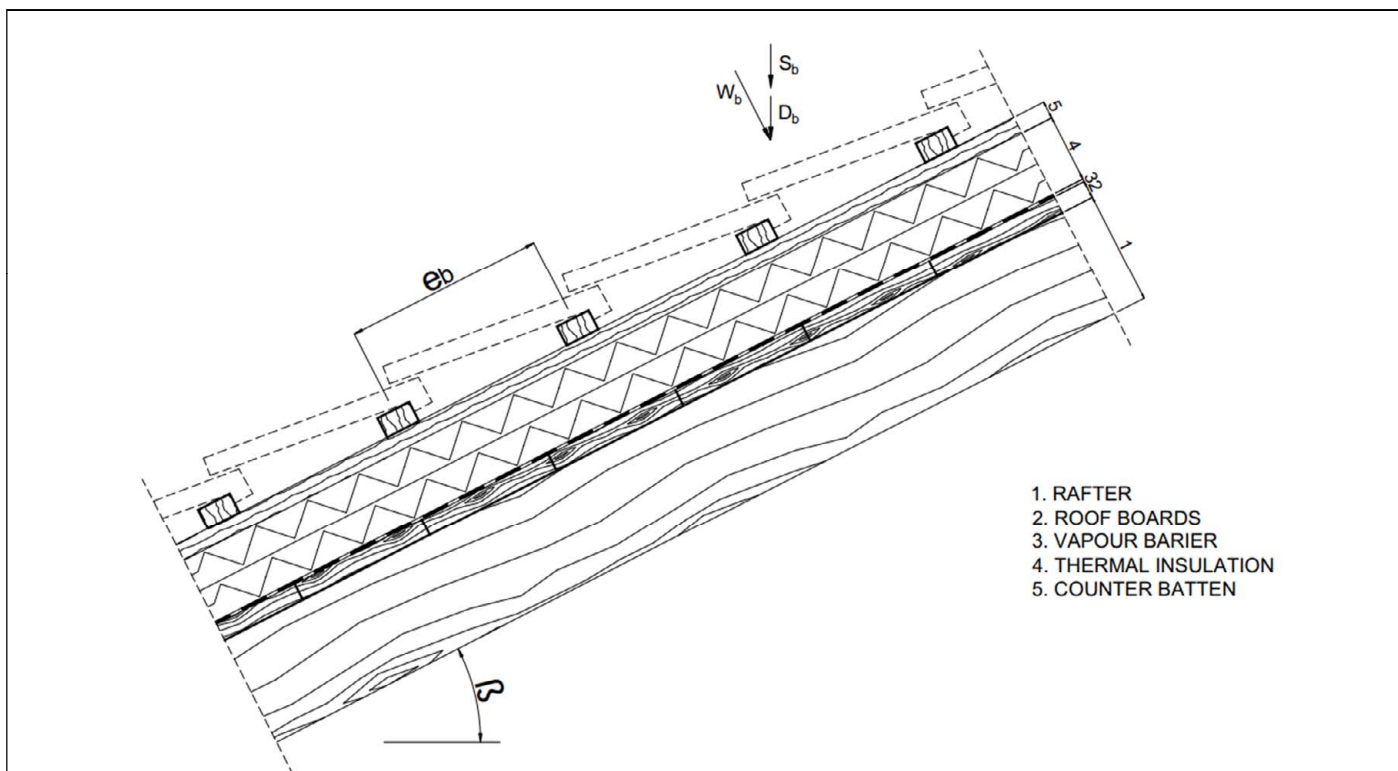

Figure A.6.2 Point loads  $F_b$  perpendicular to the counter battens

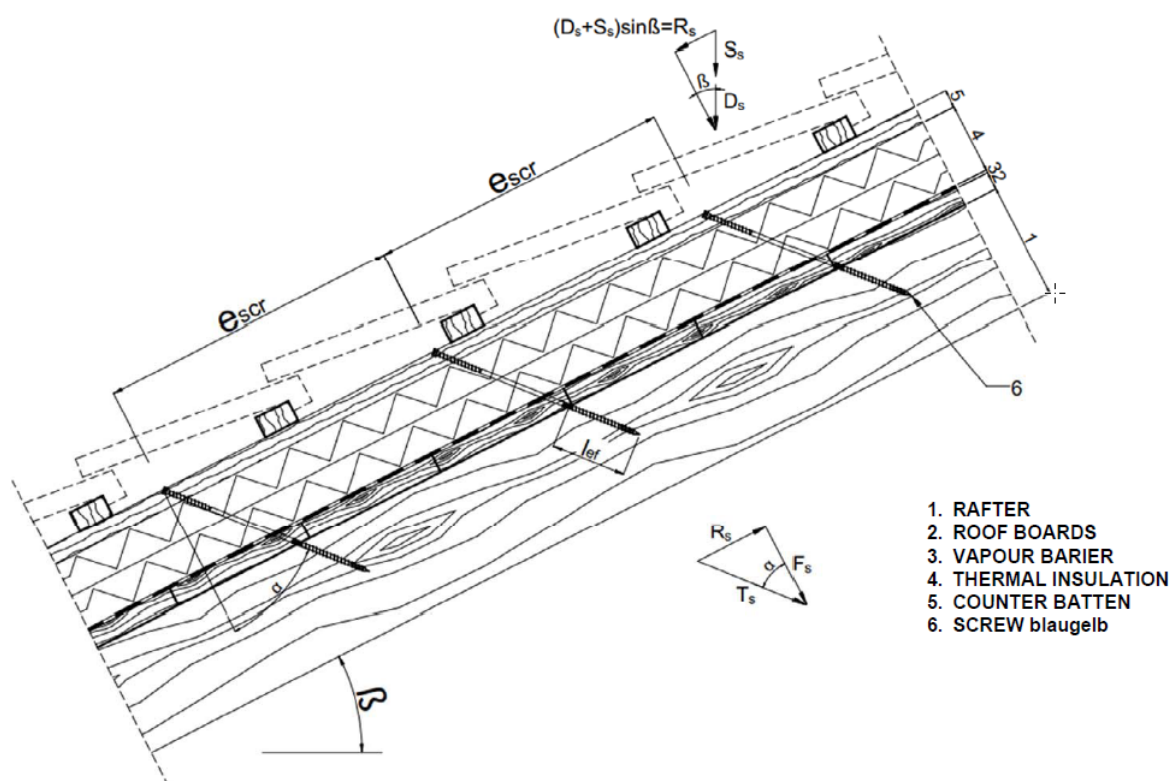

Figure A.6.3 Point loads  $F_s$  perpendicular to the counter battens, load application in the area of the screw heads

blaugelb screws	Annex 6
Fastening of thermal insulation material on top of rafters	

### A.6.2.2 Design of the counter battens

It's assumed that the spacing between the counter battens exceeds the characteristic length  $l_{char}$ .

The characteristic values of the bending stresses may be calculated as:

$$M_k = \frac{(F_{b,k} + F_{s,k}) \cdot l_{char}}{4} \quad (6.1)$$

Where

$l_{char}$  characteristic length  $l_{char} = 4 \sqrt{\frac{4 \cdot EI}{w_{ef} \cdot K}}$  (6.2)

$EI$  bending stiffness of the counter batten,

$K$  modulus of subgrade reaction,

$w_{ef}$  effective width of the thermal insulation material,

$F_{b,k}$  point loads perpendicular to the counter battens,

$F_{s,k}$  point loads perpendicular to the counter battens, load application in the area of the screw heads.

The modulus of subgrade reaction  $K$  can be calculated from the modulus of elasticity  $E_{HI}$  and the thickness  $t_{HI}$  of the thermal insulation material if the effective width  $w_{ef}$  of the thermal insulation material under compression is known. Due to the load extension in the thermal insulation material the effective width  $w_{ef}$  is greater than the width of the counter batten or rafter, respectively. For further calculations, the effective width  $w_{ef}$  of the thermal insulation material may be determined as:

$$w_{ef} = w + t_{HI} / 2 \quad (6.3)$$

Where

$w$  minimum from width of the counter batten or rafter, respectively,

$t_{HI}$  thickness of the thermal insulation material,

$$K = \frac{E_{HI}}{t_{HI}} \quad (6.4)$$

The following condition shall be satisfied:

$$\frac{\sigma_{m,d}}{f_{m,d}} = \frac{M_d}{W \cdot f_{m,d}} \leq 1 \quad (6.5)$$

For the calculation of the section modulus  $W$  the net cross section shall be considered.

The characteristic values of the shear stresses shall be calculated as:

$$V_k = \frac{(F_{b,k} + F_{s,k})}{2} \quad (6.6)$$

The following condition need to be satisfied:

$$\frac{\tau_d}{f_{v,d}} = \frac{1.5 \cdot V_d}{A \cdot f_{v,d}} \leq 1 \quad (6.7)$$

For the calculation of the cross section area the net cross section shall be considered.

blaugelb screws	Annex 6
Fastening of thermal insulation material on top of rafters	

### A.6.2.3 Design of the thermal insulation material

The characteristic value of the compressive stresses in the thermal insulation material maybe calculated as:

$$\sigma_k = \frac{1.5 \cdot F_{b,k} + F_{s,k}}{2 \cdot l_{char} \cdot w} \quad (6.8)$$

The design value of the compressive stress shall not be greater than 110 % of the compressive strength at 10 % deformation calculated in accordance with EN 826.

### A.6.2.4 Design of the screws

The screws are loaded predominantly axial. The characteristic value of the axial tension force in the screw may be calculated from the shear loads of the roof  $R_s$ :

$$T_{s,k} = \frac{R_{s,k}}{\sin \alpha} \quad (6.9)$$

The load-carrying capacity of axially loaded screws is the minimum design value of the axial withdrawal capacity of the threaded part of the screw, the head pull-through capacity of the screw and the tensile strength of the screw in accordance with Annex 2.

In order to limit the deformation of the screw head for thermal insulation material with thickness over 220 mm or with compressive strength below 0.12 N/mm<sup>2</sup>, respectively, the axial withdrawal capacity of the screws shall be reduced by the factors  $k_1$  and  $k_2$ :

For screws with partial thread:

$$F_{ax,\alpha,Rd} = \min \left\{ \frac{k_{ax} \cdot f_{ax,d} \cdot d \cdot l_{ef,r} \cdot k_1 \cdot k_2}{k_\beta} \cdot \left( \frac{\rho_{r,k}}{350} \right)^{0.8}; f_{head,d} \cdot d_h^2 \cdot \left( \frac{\rho_{b,k}}{350} \right)^{0.8}; \frac{f_{tens,k}}{Y_{M2}} \right\} \quad (6.10)$$

For screws with full thread:

$$F_{ax,\alpha,Rd} = \min \left\{ \begin{array}{l} \frac{k_{ax} \cdot f_{ax,d} \cdot d \cdot l_{ef,r} \cdot k_1 \cdot k_2}{k_\beta} \cdot \left( \frac{\rho_{r,k}}{350} \right)^{0.8} \\ \max \left\{ \frac{k_{ax} \cdot f_{ax,d} \cdot d \cdot l_{ef,b} \cdot k_1 \cdot k_2}{k_\beta} \cdot \left( \frac{\rho_{b,k}}{350} \right)^{0.8}; f_{head,d} \cdot d_h^2 \cdot \left( \frac{\rho_{b,k}}{350} \right)^{0.8} \right\} \\ \frac{f_{tens,k}}{Y_{M2}} \end{array} \right\} \quad (6.11)$$

blaugelb screws	Annex 6
Fastening of thermal insulation material on top of rafters	

Where

- $k_{ax}$  factor, taking into account the angle  $\alpha$  between screw axis and grain direction as given in clause A.2.3.2,
- $k_{\beta}$  factor as given in clause A.2.3.2,
- $f_{ax,d}$  design value of the axial withdrawal parameter of the threaded part of the screw [N/mm<sup>2</sup>],
- $d$  outer thread diameter of the screw [mm],
- $l_{ef,b}$  penetration length of the threaded part of the screw in the counter batten [mm],
- $l_{ef,r}$  penetration length of the threaded part of the screw in the rafter [mm],  $l_{ef} \geq 40$  mm,
- $\rho_{b,k}$  characteristic density of the counter batten [kg/m<sup>3</sup>], for LVL  $\leq 500$  kg/m<sup>3</sup>,
- $\rho_{r,k}$  characteristic density of the rafter [kg/m<sup>3</sup>], for LVL  $\leq 500$  kg/m<sup>3</sup>,
- $\alpha$  angle  $\alpha$  between screw axis and grain direction,  $30^\circ \leq \alpha \leq 90^\circ$ ,
- $f_{head,d}$  design value of the head pull-through parameter of the screw [N/mm<sup>2</sup>],
- $d_h$  head diameter [mm],
- $f_{tens,k}$  characteristic tensile strength the screw in accordance with Annex 2 [N],
- $\gamma_{M2}$  partial factor in accordance with EN 1993-1-1,
- $k_1$   $\min \{1; 220/t_{HI}\}$ ,
- $k_2$   $\min \{1; \sigma_{10\%}/0.12\}$ ,
- $t_{HI}$  thickness of the thermal insulation material [mm],
- $\sigma_{10\%}$  compressive stress of the thermal insulation material under 10 % deformation [N/mm<sup>2</sup>].

If equation (6.10) or (6.11) is fulfilled, the deflection of the counter battens does not need to be considered when designing the load-carrying capacity of the screws.

blaugelb screws	Annex 6
Fastening of thermal insulation material on top of rafters	

### A.6.3 Alternatively inclined screws and thermal insulation material not in compression

#### A.6.3.1 Mechanical model

Depending on the screw spacing and the arrangement of tensile and compressive screws with different inclinations the counter battens are loaded by significant bending moments. The bending moments are derived based on the following assumptions:

- The tensile and compressive loads in the screws are determined based on equilibrium conditions from the actions parallel and perpendicular to the roof plane. These actions are constant line loads  $q_{\perp}$  and  $q_{\parallel}$ .
- The screws act as hinged columns supported 10 mm within the counter batten or rafter, respectively. The effective column length consequently equals the length of the screw between counter batten and rafter plus 20 mm.
- The counter batten is considered as a continuous beam with a constant span  $\ell = A + B$ . The compressive screws constitute the supports of the continuous beam while the tensile screws transfer concentrated loads perpendicular to the counter batten axis.

The screws are predominantly loaded in withdrawal or compression, respectively. The characteristic values of the screw's normal forces are determined based on the loads parallel and perpendicular to the roof plane:

$$\text{Compressive screw: } N_{c,k} = (A + B) \cdot \left( -\frac{q_{\parallel,k}}{\cos \alpha_1 + \sin \alpha_1 / \tan \alpha_2} - \frac{q_{\perp,k} \cdot \sin(90^\circ - \alpha_2)}{\sin(\alpha_1 + \alpha_2)} \right) \quad (6.12)$$

$$\text{Tensile screw: } N_{t,k} = (A + B) \cdot \left( \frac{q_{\parallel,k}}{\cos \alpha_2 + \sin \alpha_2 / \tan \alpha_1} - \frac{q_{\perp,k} \cdot \sin(90^\circ - \alpha_1)}{\sin(\alpha_1 + \alpha_2)} \right) \quad (6.13)$$

A, B distances of the screws in accordance with Figure A.4.5,

$q_{\parallel,k}$  characteristic value of the loads parallel to the roof plane,

$q_{\perp,k}$  characteristic value of the loads perpendicular to the roof plane,

$\alpha$  angle  $\alpha_1$  and  $\alpha_2$  between screw axis and grain direction,  $30^\circ \leq \alpha_1 \leq 90^\circ$ ,  $30^\circ \leq \alpha_2 \leq 90^\circ$ .

Only screws with full or double thread are used.

The bending moments in the counter batten follow from the constant line load  $q_{\perp}$  and the load components perpendicular to the counter batten from the tensile screws. The span of the continuous beam is  $(A + B)$ . The characteristic value of the load component perpendicular to the counter batten from the tensile screw is:

$$F_{ZS,k} = (A + B) \cdot \left( \frac{q_{\parallel,k}}{1/\tan \alpha_1 + 1/\tan \alpha_2} - \frac{q_{\perp,k} \cdot \sin(90^\circ - \alpha_1) \cdot \sin \alpha_2}{\sin(\alpha_1 + \alpha_2)} \right) \quad (6.14)$$

A positive value for  $F_{ZS,k}$  means a load towards the rafter, a negative value a load away from the rafter. The system of the continuous beam is shown in Figure A.6.5.

The counter battens fixed on the rafter shall be supported perpendicular to the load-bearing plane.

blaugelb screws	Annex 6
Fastening of thermal insulation material on top of rafters	

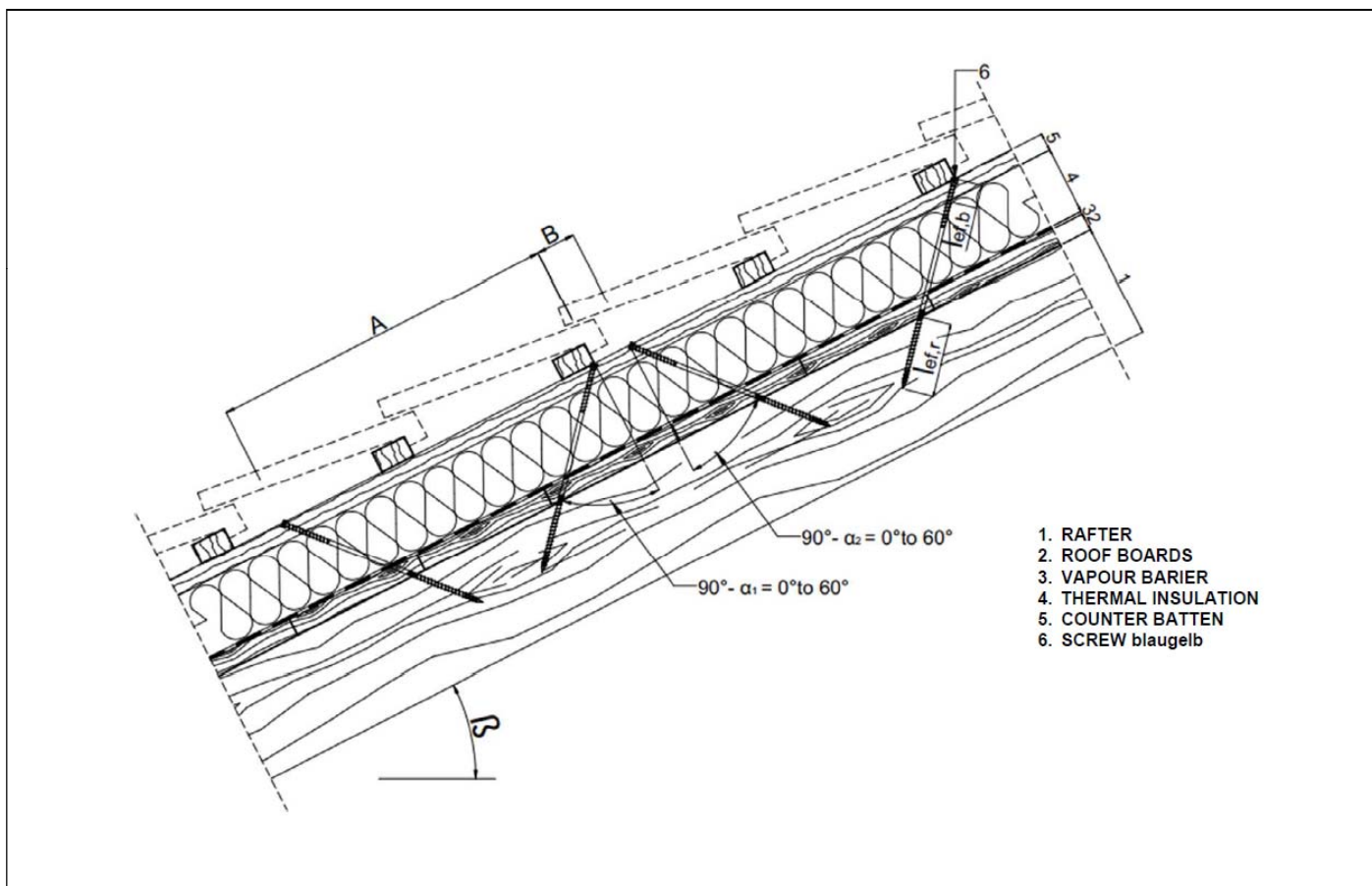

Figure A.6.4 Fastening of thermal insulation material on top of rafters – Structural system for alternatively inclined screws

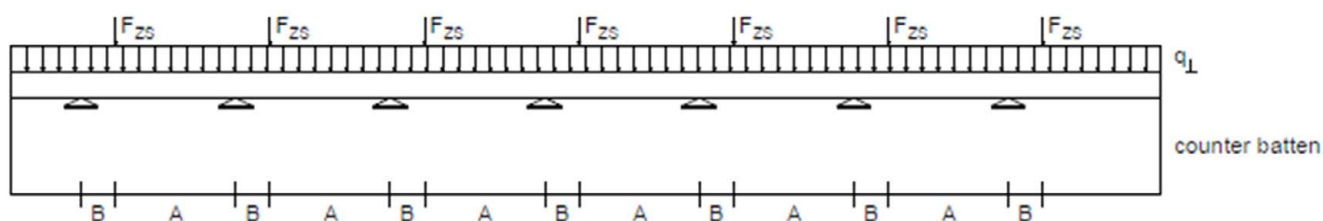

Figure A.6.5 Continuous counter batten under constant line loads from actions on the roof plane  $q_{\perp}$  and concentrated loads from tensile screws  $F_{zs}$

blaugelb screws	Annex 6
Fastening of thermal insulation material on top of rafters	

### A.6.3.2 Design of the screws

The design value of the load-carrying capacity of the screws may be calculated as given in equation (6.15) and (6.16).

Screws loaded in tension:

$$F_{ax,\alpha,Rd} = \min \left\{ \frac{k_{ax} \cdot f_{ax,d} \cdot d \cdot l_{ef,b}}{k_{\beta}} \cdot \left( \frac{\rho_{b,k}}{350} \right)^{0.8}; \frac{k_{ax} \cdot f_{ax,d} \cdot d \cdot l_{ef,r}}{k_{\beta}} \cdot \left( \frac{\rho_{r,k}}{350} \right)^{0.8}; \frac{f_{tens,k}}{\gamma_{M2}} \right\} \quad (6.15)$$

Screws loaded in compression:

$$F_{ax,\alpha,Rd} = \min \left\{ \frac{k_{ax} \cdot f_{ax,d} \cdot d \cdot l_{ef,b}}{k_{\beta}} \cdot \left( \frac{\rho_{b,k}}{350} \right)^{0.8}; \frac{k_{ax} \cdot f_{ax,d} \cdot d \cdot l_{ef,r}}{k_{\beta}} \cdot \left( \frac{\rho_{r,k}}{350} \right)^{0.8}; \frac{\kappa_c \cdot N_{pl,k}}{\gamma_{M1}} \right\} \quad (6.16)$$

Where

$k_{ax}$  factor, taking into account the angle  $\alpha$  between screw axis and grain direction as given in clause A.2.3.2,

$k_{\beta}$  factor as given in clause A.2.3.2,

$f_{ax,d}$  design value of the axial withdrawal parameter of the threaded part of the screw [N/mm<sup>2</sup>],

$d$  outer thread diameter of the screw [mm],

$l_{ef,b}$  penetration length of the threaded part of the screw in the counter batten [mm],

$l_{ef,r}$  penetration length of the threaded part of the screw in the rafter,  $l_{ef} \geq 40$  mm,

$\rho_{b,k}$  characteristic density of the counter batten [kg/m<sup>3</sup>], for LVL  $\rho_{r,k} \leq 500$  kg/m<sup>3</sup>,

$\rho_{r,k}$  characteristic density of the rafter [kg/m<sup>3</sup>], for LVL  $\rho_{r,k} \leq 500$  kg/m<sup>3</sup>,

$\alpha$  angle  $\alpha_1$  or  $\alpha_2$  between screw axis and grain direction,  $30^\circ \leq \alpha_1 \leq 90^\circ$ ,  $30^\circ \leq \alpha_2 \leq 90^\circ$ ,

$f_{tens,k}$  characteristic tensile strength of the screw in accordance with Annex 2 [N],

$\gamma_{M1}$ ,  $\gamma_{M2}$  partial factor in accordance with EN 1993-1-1,

$\kappa_c \cdot N_{pl,k}$  buckling capacity of the screw in accordance with Table A.6.2 [N].

blaugelb screws	Annex 6
Fastening of thermal insulation material on top of rafters	

Table A.6.2 Characteristic buckling capacity of screws  $\kappa_c \cdot N_{pl,k}$  in N

Free screw length $l$ between counter batten and rafter [mm]	Outer thread diameter $d$ [mm]					
	WKPS/WKPC/WKPP screws			WKFS/WKFC/WKFP and WKFS-SD/WKFC-SD/WKFP-SD screws		
	6.0	8.0	10.0	6.0	8.0	10.0
	$\kappa_c \cdot N_{pl,k}$ [N]					
≤ 100	1370	4680	8720	1370	3520	7780
120	1040	3580	6760	1040	2680	6010
140	810	2820	5360	810	2100	4760
160	650	2280	4350	650	1700	3860
180	530	1880	3600	530	1400	3190
200	440	1570	3030	440	1170	2680
220	370	1330	2580	370	990	2280
240		1150	2220		850	1960
260		1000	1930		740	1710
280		870	1690		650	1500
300		770	1500		570	1320
320		690	1340		510	1180
340		620			460	1060
360		560			410	950
380		500			370	860
400		460			340	790
420					310	720
440						660
460						610
480						560
500						520
520						480

blaugelb screws

Fastening of thermal insulation material on top of rafters

Annex 6



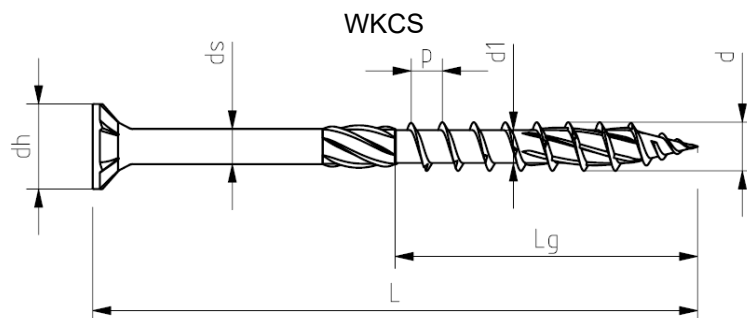

<b>d [mm]</b>	<b>3,0<sup>±0,3</sup></b>	<b>3,5<sup>±0,3</sup></b>	<b>4,0<sup>±0,3</sup></b>	<b>4,5<sup>±0,3</sup></b>	<b>5,0<sup>±0,3</sup></b>	<b>6,0<sup>±0,3</sup></b>	<b>6,0<sup>±0,3</sup></b>	<b>8,0<sup>±0,4</sup></b>	<b>10,0<sup>±0,5</sup></b>
<b>d<sub>h</sub> [mm]</b>	<b>6,0<sup>±0,5</sup></b>	<b>7,0<sup>±0,5</sup></b>	<b>8,0<sup>±0,5</sup></b>	<b>9,0<sup>±0,6</sup></b>	<b>10,0<sup>±0,6</sup></b>	<b>12,0<sup>±0,6</sup></b>	<b>12,0<sup>±0,6</sup></b>	<b>14,0<sup>±0,7</sup></b>	<b>18,0<sup>±0,9</sup></b>
<b>d<sub>s</sub> [mm]</b>	<b>2,2<sup>±0,3</sup></b>	<b>2,50<sup>±0,3</sup></b>	<b>2,87<sup>±0,3</sup></b>	<b>3,1<sup>±0,3</sup></b>	<b>3,5<sup>±0,3</sup></b>	<b>4,3<sup>±0,3</sup></b>	<b>4,3<sup>±0,3</sup></b>	<b>5,78<sup>±0,3</sup></b>	<b>7,0<sup>±0,35</sup></b>
<b>d<sub>1</sub> [mm]</b>	<b>2,0<sup>±0,3</sup></b>	<b>2,25<sup>±0,3</sup></b>	<b>2,55<sup>±0,3</sup></b>	<b>2,95<sup>±0,3</sup></b>	<b>3,15<sup>±0,3</sup></b>	<b>3,8<sup>±0,3</sup></b>	<b>3,8<sup>±0,3</sup></b>	<b>5,5<sup>±0,3</sup></b>	<b>6,3<sup>±0,315</sup></b>
<b>p [mm]</b>	<b>1,5<sup>±0,15</sup></b>	<b>1,8<sup>±0,18</sup></b>	<b>2,0<sup>±0,20</sup></b>	<b>2,2<sup>±0,22</sup></b>	<b>2,6<sup>±0,26</sup></b>	<b>4,5<sup>±0,45</sup></b>	<b>3,3<sup>±0,33</sup></b>	<b>5,6<sup>±0,56</sup></b>	<b>6,0<sup>±0,60</sup></b>

<b>d=3,0</b>		<b>d=3,5</b>		<b>d=4,0</b>		<b>d=4,5</b>		<b>d=5,0</b>	
<b>L [mm]</b>	<b>L<sub>g</sub> [mm]</b>	<b>L [mm]</b>	<b>L<sub>g</sub> [mm]</b>	<b>L [mm]</b>	<b>L<sub>g</sub> [mm]</b>	<b>L [mm]</b>	<b>L<sub>g</sub> [mm]</b>	<b>L [mm]</b>	<b>L<sub>g</sub> [mm]</b>
30-40	17-22	30-50	17-30	30-70	17-40	40-80	22-50	40-120	22-60

<b>d=6,0</b>		<b>d=8,0</b>		<b>d=10,0</b>	
<b>L [mm]</b>	<b>L<sub>g</sub> [mm]</b>	<b>L [mm]</b>	<b>L<sub>g</sub> [mm]</b>	<b>L [mm]</b>	<b>L<sub>g</sub> [mm]</b>
50-300	30-75	40-60 <sup>1)</sup>	35-50	60-70 <sup>1)</sup>	50
		70-600	50-100	80-600	50-100

<sup>1)</sup>without milling cutter above thread

blaugelb screws

WKCS

d = 3 mm, d = 3,5 mm, d = 4 mm, d = 4,5 mm, d = 5 mm, d = 6 mm, d = 8 mm, d = 10 mm

Annex 7.1

WKCP

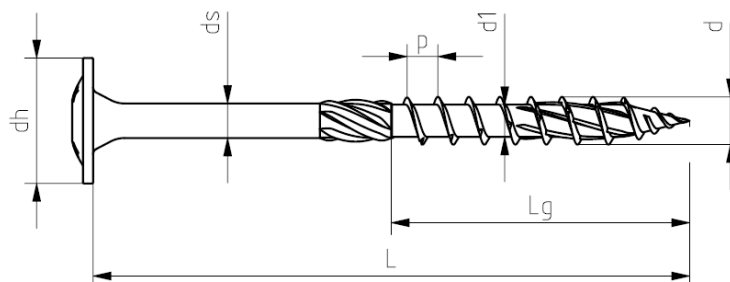

<b>d [mm]</b>	<b>5,0<sup>±0,3</sup></b>	<b>6,0<sup>±0,3</sup></b>	<b>6,0<sup>±0,3</sup></b>	<b>8,0<sup>±0,4</sup></b>	<b>10,0<sup>±0,5</sup></b>
<b>d<sub>h</sub> [mm]</b>	<b>12,0<sup>±0,6</sup></b>	<b>14,0<sup>±0,7</sup></b>	<b>14,0<sup>±0,7</sup></b>	<b>21,0<sup>±1,05</sup></b>	<b>25,0<sup>±1,25</sup></b>
<b>d<sub>s</sub> [mm]</b>	<b>3,5<sup>±0,3</sup></b>	<b>4,3<sup>±0,3</sup></b>	<b>4,3<sup>±0,3</sup></b>	<b>5,78<sup>±0,3</sup></b>	<b>7,0<sup>±0,35</sup></b>
<b>d<sub>1</sub> [mm]</b>	<b>3,15<sup>±0,3</sup></b>	<b>3,8<sup>±0,3</sup></b>	<b>3,8<sup>±0,3</sup></b>	<b>5,5<sup>±0,3</sup></b>	<b>6,3<sup>±0,315</sup></b>
<b>p [mm]</b>	<b>2,6<sup>±0,26</sup></b>	<b>4,5<sup>±0,45</sup></b>	<b>3,3<sup>±0,33</sup></b>	<b>5,6<sup>±0,56</sup></b>	<b>6,0<sup>±0,60</sup></b>

<b>d=5,0</b>		<b>d=6,0</b>		<b>d=8,0</b>		<b>d=10,0</b>	
<b>L [mm]</b>	<b>L<sub>g</sub> [mm]</b>	<b>L [mm]</b>	<b>L<sub>g</sub> [mm]</b>	<b>L [mm]</b>	<b>L<sub>g</sub> [mm]</b>	<b>L [mm]</b>	<b>L<sub>g</sub> [mm]</b>
40-120	22-60	50-300	30-75	40-60 <sup>1)</sup>	35-50	60-70 <sup>1)</sup>	50
				70-600	50-100	80-600	50-100

<sup>1)</sup> without milling cutter above thread

blaugelb screws

WKCP  
d = 5 mm, d = 6 mm, d = 8 mm, d = 10 mm

Annex 7.2

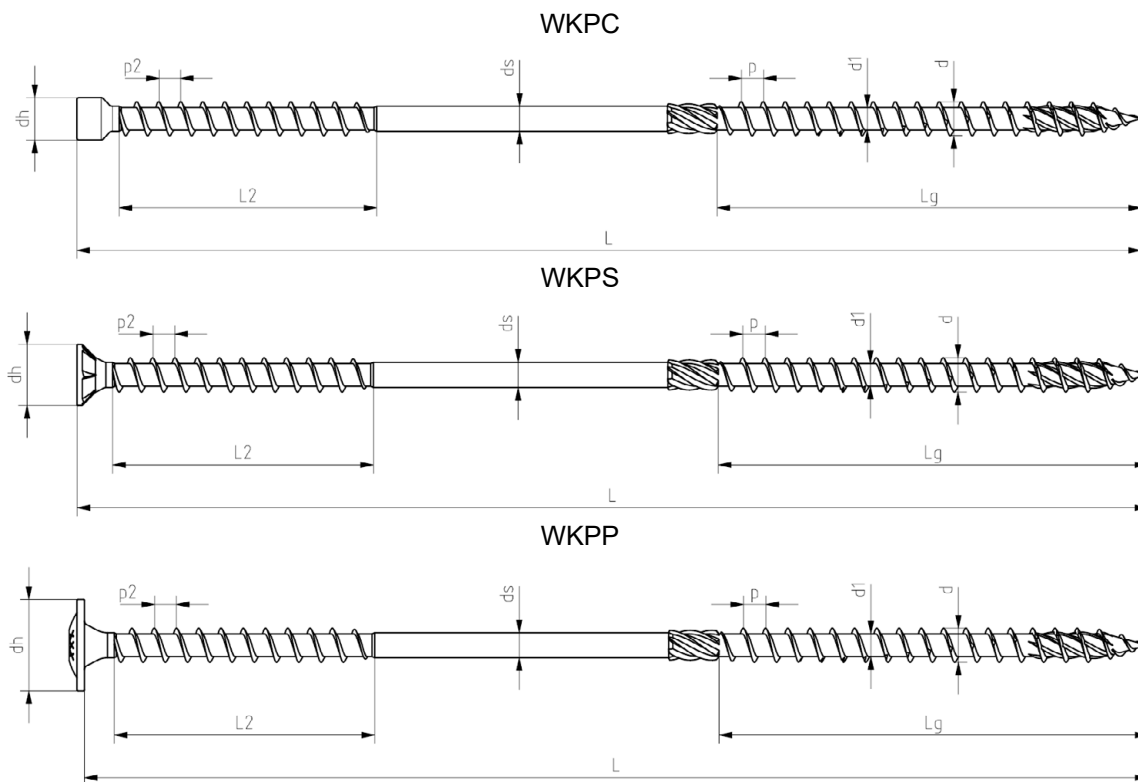

<b>d [mm]</b>	<b>8,0<sup>±0,4</sup></b>
<b>d<sub>h</sub>[mm] WKPC</b>	<b>10,0<sup>±1,0</sup></b>
<b>d<sub>h</sub>[mm] WKPS</b>	<b>14,0<sup>±0,7</sup></b>
<b>d<sub>h</sub>[mm] WKPP</b>	<b>21,0<sup>±1,05</sup></b>
<b>d<sub>s</sub> [mm]</b>	<b>5,78<sup>±0,3</sup></b>
<b>d<sub>1</sub> [mm]</b>	<b>5,4<sup>±0,3</sup></b>
<b>d<sub>2</sub> [mm]</b>	<b>8,0<sup>±0,4</sup></b>
<b>p [mm]</b>	<b>5,6<sup>±0,56</sup></b>
<b>p<sub>2</sub> [mm]</b>	<b>5,6<sup>±0,56</sup></b>
<b>L<sub>2</sub> [mm]</b>	<b>60<sup>±2,3</sup></b>

<b>d=8,0</b>	
<b>L [mm]</b>	<b>L<sub>g</sub> [mm]</b>
165-472	80-100

blaugelb screws

WKPC, WKPS, WKPP  
d = 8 mm

Annex 7.3

WKLC

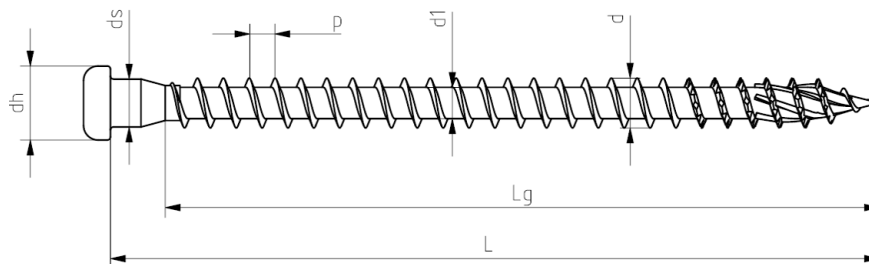

<b>d [mm]</b>	<b>5,0<sup>±0,3</sup></b>
<b>d<sub>h</sub> [mm]</b>	<b>7,4<sup>±0,5</sup></b>
<b>d<sub>s</sub> [mm]</b>	<b>4,8<sup>±0,3</sup></b>
<b>d<sub>1</sub> [mm]</b>	<b>3,15<sup>±0,3</sup></b>
<b>p [mm]</b>	<b>2,6<sup>±0,26</sup></b>

<b>d=5,0</b>	
<b>L [mm]</b>	<b>L<sub>g</sub> [mm]</b>
30-70	22-60

blaugelb screws

WKLC  
d = 5 mm

Annex 7.4

WKCH

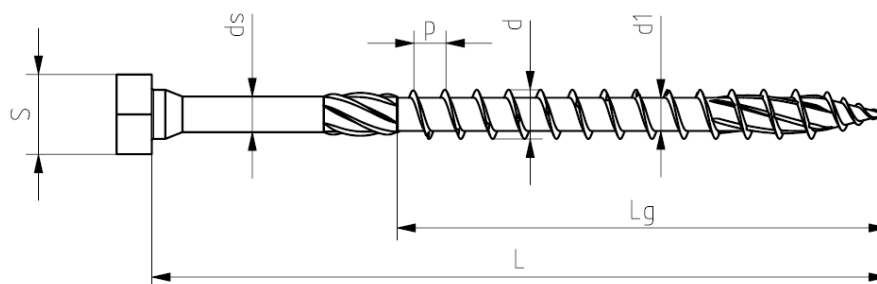

<b>d [mm]</b>	<b>6,0<sup>±0,3</sup></b>	<b>6,0<sup>±0,3</sup></b>	<b>8,0<sup>±0,4</sup></b>	<b>10,0<sup>±0,5</sup></b>
<b>d<sub>h</sub>[mm]</b>	<b>10,0<sup>±0,6</sup></b>	<b>10,0<sup>±0,6</sup></b>	<b>13,0<sup>±0,65</sup></b>	<b>15,0<sup>±1,5</sup></b>
<b>d<sub>s</sub> [mm]</b>	<b>4,3<sup>±0,3</sup></b>	<b>4,3<sup>±0,3</sup></b>	<b>5,78<sup>±0,3</sup></b>	<b>7,0<sup>±0,35</sup></b>
<b>d<sub>1</sub> [mm]</b>	<b>3,8<sup>±0,3</sup></b>	<b>3,8<sup>±0,3</sup></b>	<b>5,5<sup>±0,3</sup></b>	<b>6,3<sup>±0,315</sup></b>
<b>p [mm]</b>	<b>4,5<sup>±0,45</sup></b>	<b>3,3<sup>±0,33</sup></b>	<b>5,6<sup>±0,56</sup></b>	<b>6,0<sup>±0,60</sup></b>

<b>d=6,0</b>		<b>d=8,0</b>		<b>d=10,0</b>	
<b>L [mm]</b>	<b>L<sub>g</sub> [mm]</b>	<b>L [mm]</b>	<b>L<sub>g</sub> [mm]</b>	<b>L [mm]</b>	<b>L<sub>g</sub> [mm]</b>
50-300	30-75	40-60 <sup>1)</sup>	35-50	60-70 <sup>1)</sup>	50
		70-600	50-100	80-600	50-100

<sup>1)</sup> without milling cutter above thread

blaugelb screws

WKCH  
d = 6 mm, 8 mm, 10 mm

Annex 7.5

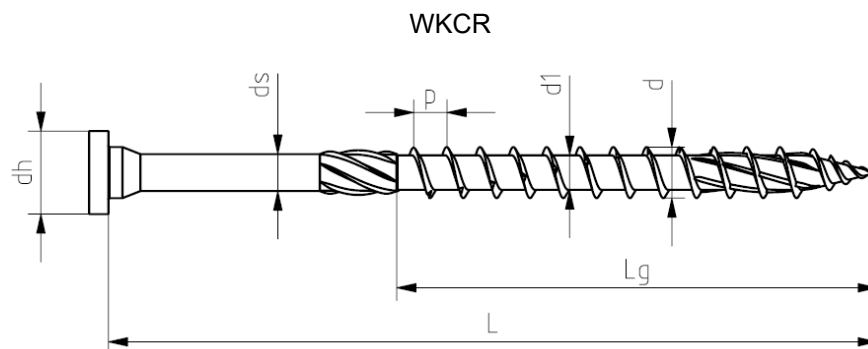

<b>d [mm]</b>	<b>6,0<sup>±0,3</sup></b>	<b>6,0<sup>±0,3</sup></b>	<b>8,0<sup>±0,4</sup></b>	<b>10,0<sup>±0,5</sup></b>
<b>d<sub>h</sub>[mm]</b>	<b>10,0<sup>±0,6</sup></b>	<b>10,0<sup>±0,6</sup></b>	<b>13,0<sup>±0,65</sup></b>	<b>15,0<sup>±1,5</sup></b>
<b>d<sub>s</sub> [mm]</b>	<b>4,3<sup>±0,3</sup></b>	<b>4,3<sup>±0,3</sup></b>	<b>5,78<sup>±0,3</sup></b>	<b>7,0<sup>±0,35</sup></b>
<b>d<sub>1</sub> [mm]</b>	<b>3,8<sup>±0,3</sup></b>	<b>3,8<sup>±0,3</sup></b>	<b>5,5<sup>±0,3</sup></b>	<b>6,3<sup>±0,315</sup></b>
<b>p [mm]</b>	<b>4,5<sup>±0,45</sup></b>	<b>3,3<sup>±0,33</sup></b>	<b>5,6<sup>±0,56</sup></b>	<b>6,0<sup>±0,60</sup></b>

d=6,0		d=8,0		d=10,0	
L [mm]	L <sub>g</sub> [mm]	L [mm]	L <sub>g</sub> [mm]	L [mm]	L <sub>g</sub> [mm]
50-300	30-75	40-60 <sup>1)</sup>	35-50	60-70 <sup>1)</sup>	50
		70-600	50-100	80-600	50-100

<sup>1)</sup> without milling cutter above thread

blaugelb screws

WKCR  
d = 6 mm, 8 mm, 10 mm

Annex 7.6

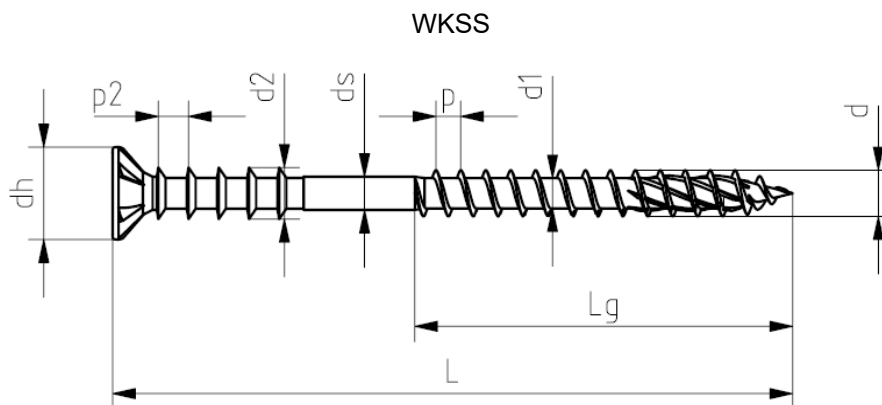

<b>d [mm]</b>	<b>6,0<sup>±0,3</sup></b>
<b>d<sub>h</sub> [mm]</b>	<b>12,0<sup>±0,6</sup></b>
<b>d<sub>s</sub> [mm]</b>	<b>4,3<sup>±0,3</sup></b>
<b>d<sub>1</sub> [mm]</b>	<b>3,9<sup>±0,3</sup></b>
<b>p [mm]</b>	<b>3,3<sup>±0,33</sup></b>
<b>d<sub>2</sub> [mm]</b>	<b>6,7<sup>±0,33</sup></b>
<b>p<sub>2</sub> [mm]</b>	<b>4,0<sup>±0,4</sup></b>

<b>d=6,0</b>	
<b>L [mm]</b>	<b>L<sub>g</sub> [mm]</b>
50-300	25-75

blaugelb screws

WKSS  
d = 6 mm

Annex 7.7

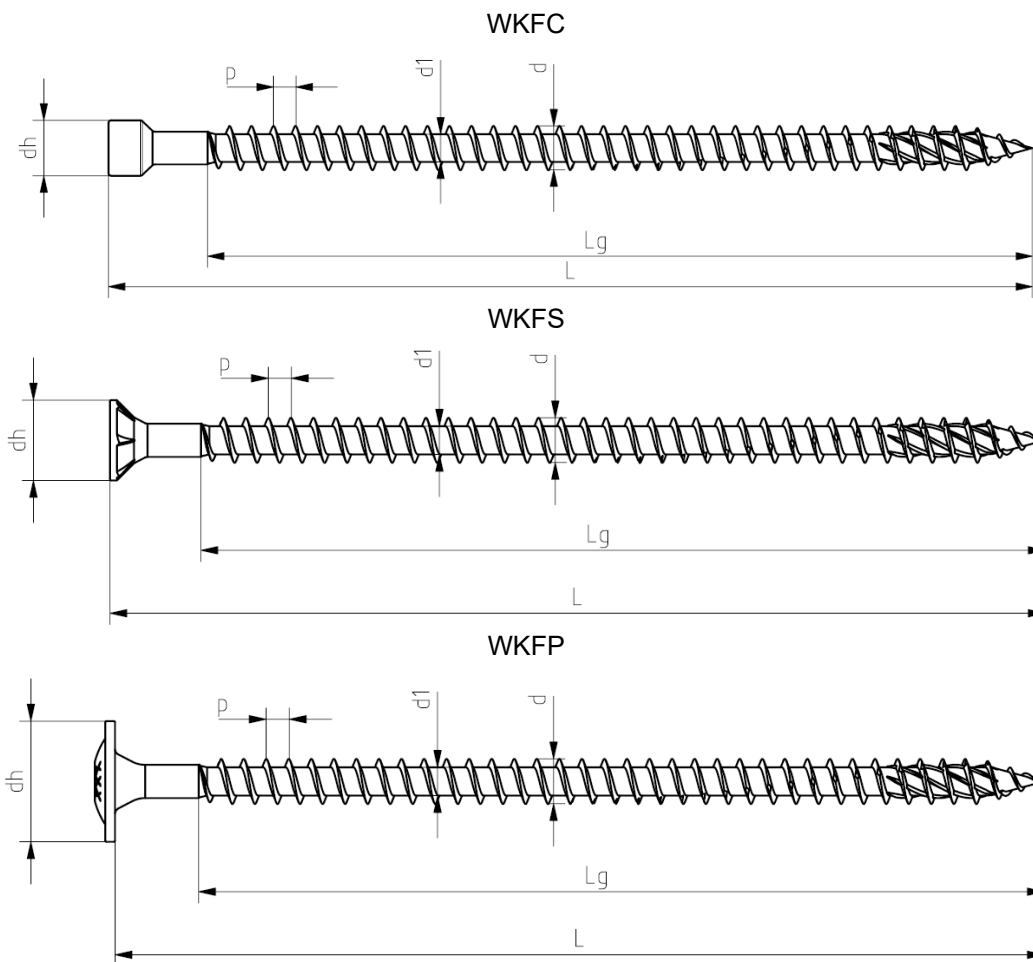

<b>d [mm]</b>	<b>6,0<sup>±0,3</sup></b>	<b>8,0<sup>±0,4</sup></b>	<b>10,0<sup>±0,5</sup></b>
<b>d<sub>h</sub> [mm] WKFC</b>	<b>8,0<sup>±0,5</sup></b>	<b>10,0<sup>±0,6</sup></b>	<b>13,0<sup>±0,65</sup></b>
<b>d<sub>h</sub> [mm] WKFS</b>	<b>12,0<sup>±0,6</sup></b>	<b>14,0<sup>±0,7</sup></b>	<b>18,0<sup>±0,9</sup></b>
<b>d<sub>h</sub> [mm] WKFP</b>	<b>14,0<sup>±0,7</sup></b>	<b>21,0<sup>±1,05</sup></b>	<b>25,0<sup>±1,25</sup></b>
<b>d<sub>s</sub> [mm]</b>	<b>4,3<sup>±0,3</sup></b>	<b>5,78<sup>±0,3</sup></b>	<b>7,0<sup>±0,35</sup></b>
<b>d<sub>1</sub> [mm]</b>	<b>3,85<sup>±0,3</sup></b>	<b>4,95<sup>±0,3</sup></b>	<b>6,0<sup>±0,3</sup></b>
<b>p [mm]</b>	<b>3,3<sup>±0,33</sup></b>	<b>4,0<sup>±0,4</sup></b>	<b>4,6<sup>±0,46</sup></b>

<b>d=6,0</b>		<b>d=8,0</b>		<b>d=10,0</b>	
<b>L [mm]</b>	<b>L<sub>g</sub> [mm]</b>	<b>L [mm]</b>	<b>L<sub>g</sub> [mm]</b>	<b>L [mm]</b>	<b>L<sub>g</sub> [mm]</b>
50-300	I-8	80-500	I-12	100-600	I-15

blaugelb screws

WKFC, WKFS, WKFP  
d = 6 mm, d = 8 mm, d = 10 mm

Annex 7.8



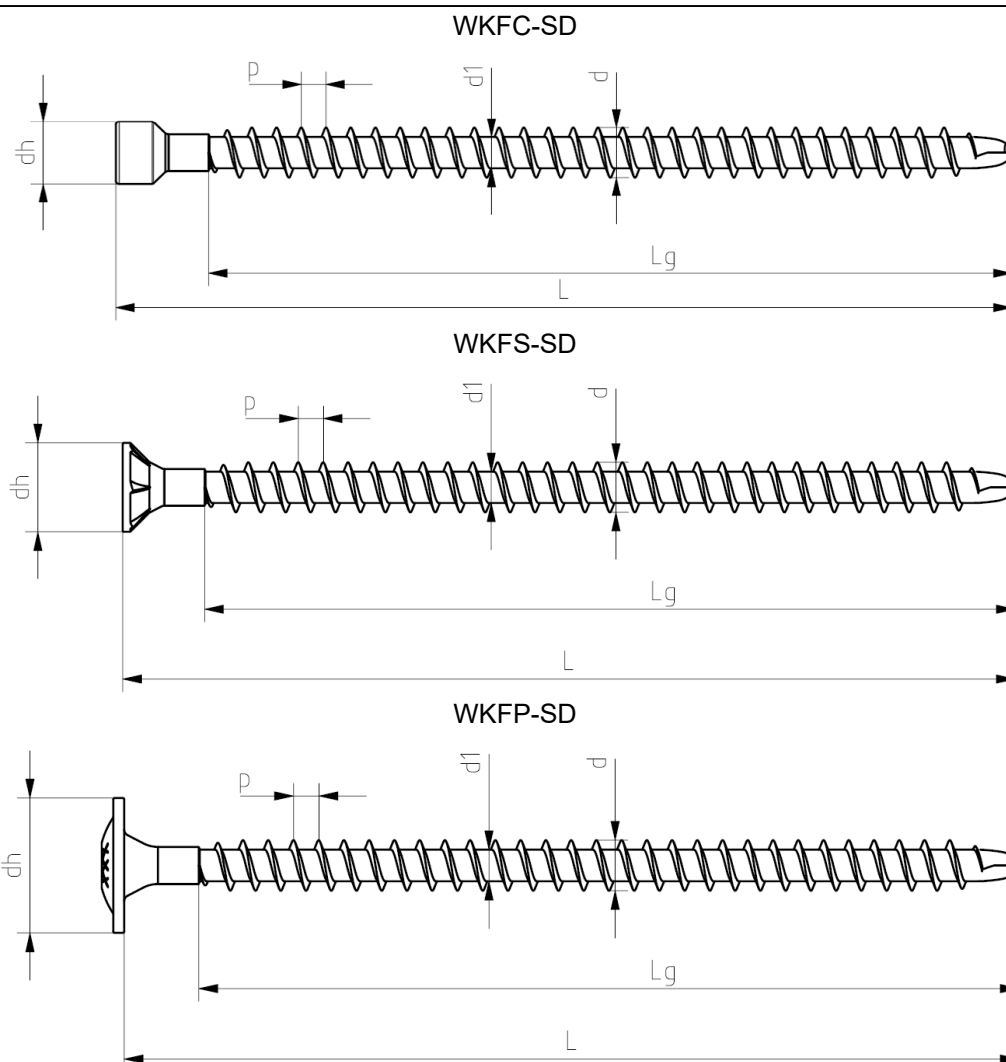

<b>d [mm]</b>	<b>6,0<sup>±0,3</sup></b>	<b>8,0<sup>±0,4</sup></b>	<b>10,0<sup>±0,5</sup></b>
<b>d<sub>h</sub> [mm] WKFC-SD</b>	<b>8,0<sup>±0,5</sup></b>	<b>10,0<sup>±0,6</sup></b>	<b>13,0<sup>±0,65</sup></b>
<b>d<sub>h</sub> [mm] WKFS-SD</b>	<b>12,0<sup>±0,6</sup></b>	<b>14,0<sup>±0,7</sup></b>	<b>18,0<sup>±0,9</sup></b>
<b>d<sub>h</sub> [mm] WKFP-SD</b>	<b>14,0<sup>±0,7</sup></b>	<b>21,0<sup>±1,05</sup></b>	<b>25,0<sup>±1,25</sup></b>
<b>d<sub>s</sub> [mm]</b>	<b>4,3<sup>±0,3</sup></b>	<b>5,78<sup>±0,3</sup></b>	<b>7,0<sup>±0,35</sup></b>
<b>d<sub>1</sub> [mm]</b>	<b>3,85<sup>±0,3</sup></b>	<b>4,95<sup>±0,3</sup></b>	<b>6,0<sup>±0,3</sup></b>
<b>p [mm]</b>	<b>3,3<sup>±0,33</sup></b>	<b>4,0<sup>±0,4</sup></b>	<b>4,6<sup>±0,46</sup></b>

<b>d=6,0</b>		<b>d=8,0</b>		<b>d=10,0</b>	
<b>L [mm]</b>	<b>L<sub>g</sub> [mm]</b>	<b>L [mm]</b>	<b>L<sub>g</sub> [mm]</b>	<b>L [mm]</b>	<b>L<sub>g</sub> [mm]</b>
50-300	I-8	80-500	I-12	100-600	I-15

Tolerances of dimensions L, L <sub>g</sub> [mm]											
From	10	18	30	50	80	120	180	250	315	400	500
To	18	30	50	80	120	180	250	315	400	500	630
Tolerance	±1,5	±1,7	±2,0	±2,3	±2,7	±3,2	±3,6	±4,1	±4,5	±4,9	±5,5

blaugelb Washer

WKFC-SD, WKFS-SD, WKFP-SD  
d = 6 mm, d = 8 mm, d = 10 mm

Annex 7.9

PWKCS

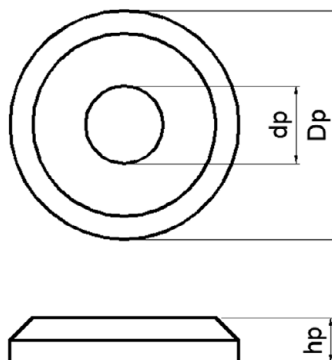

Nom.	Ø6,0	Ø8,0	Ø10,0
$d_p$ [mm]	$7,5^{±0,5}$	$8,5^{±0,5}$	$11,0^{±0,5}$
$D_p$ [mm]	$20,0^{±1,0}$	$25,0^{±1,25}$	$32,0^{±1,6}$
$h_p$ [mm]	$4,0^{±0,3}$	$5,0^{±0,3}$	$6,0^{±0,3}$

blaugelb screws

PWKCS  
d = 6 mm, d = 8 mm, d = 10 mm

Annex 7.10