



Austrian Institute of Construction Engineering
Schenkenstrasse 4 | T+43 1 533 65 50
1010 Vienna | Austria | F+43 1 533 64 23
www.oib.or.at | mail@oib.or.at



European Technical Assessment

ETA-23/0620
of 25.09.2023

General part

Technical Assessment Body issuing the European Technical Assessment

Österreichisches Institut für Bautechnik (OIB)
Austrian Institute of Construction Engineering

Trade name of the construction product

blaugelb Trio**therm**⁺ System

Product family to which the construction product belongs

Pre-wall mounting kit for windows and doors

Manufacturer

Meesenburg Großhandel KG
Westerallee 162
24941 Flensburg
Germany

Manufacturing plant(s)

Meesenburg Großhandel KG
Westerallee 162
24941 Flensburg
Germany

This European Technical Assessment contains

16 pages including 3 Annexes which form an integral part of this assessment.

This European Technical Assessment is issued in accordance with Regulation (EU) No 305/2011, on the basis of

European Assessment document (EAD)
041871-00-1201 "Pre-wall mounting kit for windows and doors".

In addition to the specific clauses relating to dangerous substances contained in this European Technical Assessment, there may be other requirements applicable to the kits falling within its scope (e.g. transposed European legislation and national laws, regulations and administrative provisions).

In order to meet the provisions of the EU Construction Products Directive, these requirements need also to be complied with, when and where they apply.

The ETA will contain the generic specification of the other components of the assembled system, which are not part of the kit.

Translations of this European Technical Assessment in other languages shall fully correspond to the original issued document and should be identified as such.

Communication of this European Technical Assessment, including transmission by electronic means, shall be in full. However, partial reproduction can be made with the written consent of the Österreichisches Institut für Bautechnik. Any partial reproduction has to be identified as such.

Specific parts

1. Technical description of the product

The pre-wall installation system "blaugelb Triotherm⁺ System" consists of factory-prefabricated, contour-defined, linear installation profiles made of expanded polystyrene (EPS) according to EN 13163, a load-bearing linear seal (2 sealing beads) between the load-bearing outer wall and the installation profile made of silane-modified polymer "blaugelb Hybrid Polymer Power Fix" and force-transmitting connection elements made of factory-made screws "blaugelb Rahmenfixschraube".

The mounting profile with a bulk density of $\geq 150 \text{ kg/m}^3$ is manufactured in one piece, is attached to the load-bearing outer wall with at least 2 fasteners per mounting profile and can be endlessly extended using dovetail joints. The mounting profiles frame the wall opening and thus form the anchoring substrate for fastening the prefabricated building elements (e.g. windows).

Window frame screws "blaugelb Rahmenfixschraube" are used as an optional auxiliary component for fastening the prefabricated components.

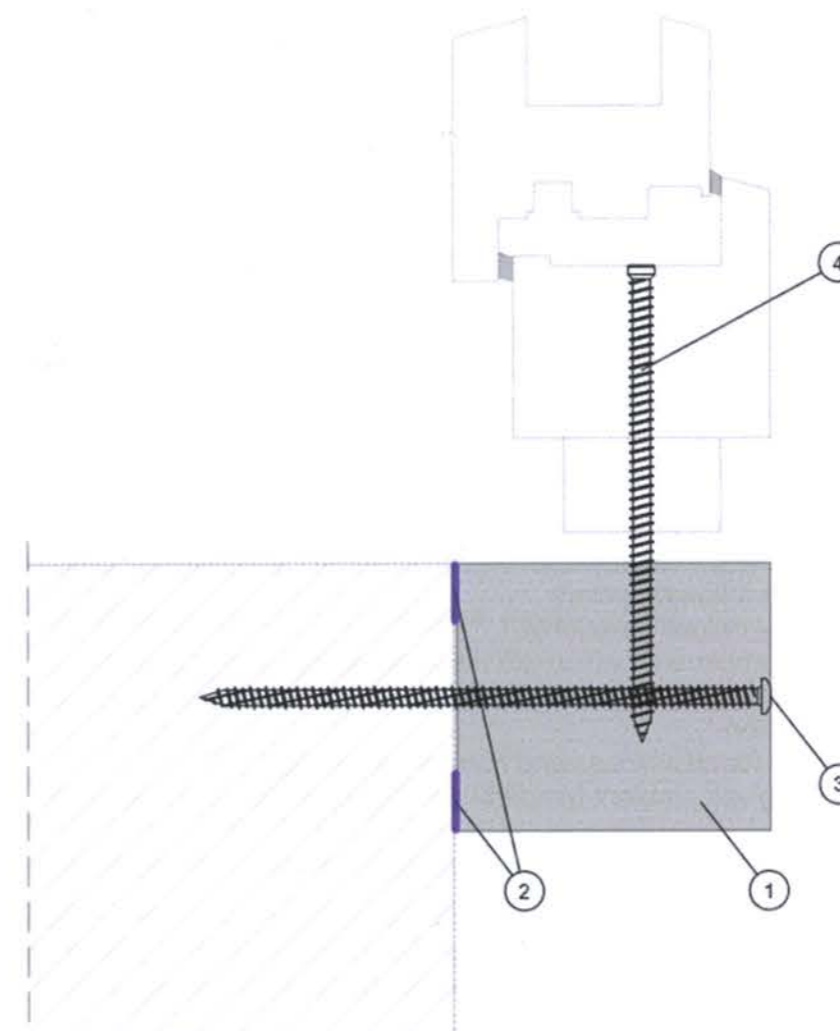

Fig. 1: Components of "blaugelb Triotherm⁺ System":

- ① mounting profile "blaugelb Triotherm⁺"
- ② load-bearing sealing "blaugelb Hybrid Polymer Power Fix"
- ③ force-transmitting connection element "blaugelb Rahmenfixschraube"
- ④ window frame screw "blaugelb Rahmenfixschraube"

Depending on the magnitude of the force, 1 or 2 screws are required for the force-transmitting fastening points, in the following termed single screw and twin screw. In the case of very high

forces acting parallel to the window plane, the force-transmitting fastening points must be supplemented with supports. The supports consist of the "blaugelb Triotherm⁺" mounting profile with a length of 150 mm or 200 mm and are fastened with 2 "blaugelb Rahmenfixschraube" per support (see Figure 2).

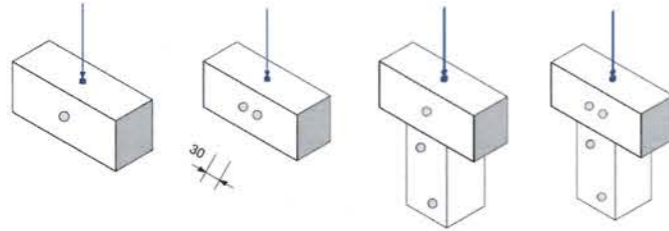

Figure 2: Design options for the force-transmitting attachment points, seen from left to right, with single screw, with twin screws, with single screws and support, and with twin screws and support

See Annex A for more details on the product description.

2. Specification of the intended use in accordance with the applicable European Assessment Document (hereinafter EAD)

"blaugelb Triotherm⁺ System" is used as a fastening substrate for prefabricated building elements in the insulation level of load-bearing exterior walls in new construction and renovation. The PWMK is intended for use in building structures to transfer forces, such as the dead weight of the building elements, wind and live loads and, if necessary, loads for fall protection and burglar resistance into the load-bearing exterior wall.

This European Technical Assessment, based on the provisions, test and assessment methods in EAD 041871-00-1201 have been written based upon the assumed intended working life of the kit for the intended use of 25 years. The indications given on the working life cannot be interpreted as a guarantee given by the producer, but are regarded only as a means for choosing the right products in relation to the expected economically reasonable working life of the works.

The levels of use categories and the performances of the kit can be assumed only, if the installation is carried out according to the installation instructions of the manufacturer, in particular taking account of the following points:

- installation by appropriately trained personnel,
- installation of only those components which are marked components of the kit,
- installation with required tools and adjuvants for details as corners, connections etc.
- precautions during installation,
- inspecting the wall surface for cleanliness and correct preparation,
- finding out whether to the given ambient temperature the application with the adjustment has to be accomplished,
- inspections during installation and of the finished product and documentation of the results.

"blaugelb Triotherm⁺ System" shall be installed and used in accordance with the technical product literature of the manufacturer. The information as to the method of repair on site and handling of waste products shall be observed. Details of installation instructions are given in Annex C.

3. Performance of the product and references to the methods used for its Assessment

Basic requirements for construction works	Characteristics
BWR 2	Safety in case of fire
BWR 3	Hygiene, health and environment
BWR 4	Safety and accessibility in use
BWR 5	Sound insulation
BWR 6	Energy economy and thermal insulation

3.1 Safety in case of fire (BWR 2)

3.1.1 Reaction to fire of the mounting profile and the sealing material

According to EN 13501-1 "blaugelb Triotherm⁺ System" and "blaugelb Hybrid Polymer Power Fix" fulfil the requirements for reaction to fire class E.

According to EAD 041871-00-1201 "blaugelb Rahmenfixschraube" fulfils the requirements for reaction to fire class A1.

3.2 Hygiene, health and environment (BWR 3)

3.2.1 Watertightness of the connection to the load-bearing exterior wall

Driving rain tightness: 600 Pa

3.3 Safety and accessibility in use (BWR 4)

3.3.1 Compressive, bending stiffness of the mounting profile

	minimum	mean	maximum
Compressive strength at 2 % compression σ_2	1,245 N/mm ²	1,273 N/mm ²	1,300 N/mm ²
Compressive strength at 10 % compression σ_{10}	1,934 N/mm ²	1,994 N/mm ²	2,071 N/mm ²
Bending stress σ_B	1,938 N/mm ²	2,104 N/mm ²	2,417 N/mm ²

3.3.2 Absorption of vertical and horizontal loads of the PWMK

3.3.2.1 Load-bearing capacity

Load-bearing capacity perpendicular to the window plane: see Annex B

Load-bearing capacity parallel to the window plane: see Annex B

Excerpt from the mounting profile

Single screw F_{Rk} 1,70 kN

Twin screw F_{Rk} 3,54 kN

Transverse load of the mounting profile:

Single screw: joint width \leq 11mm F_{Rk} 1,21 kN

Single screw: joint width \leq 21mm F_{Rk} 1,06 kN

Twin screw: joint width \leq 11mm with increased screw depth: 80 mm F_{Rk} 2,84 kN

Twin screw: joint width \leq 21mm F_{Rk} 1,99 kN

3.3.2.2 Proof of function and durability

Mechanical stress: Class 2 and 10.000 cycles

Resistance to loads at wing level: Class 4 and 800 N (tested up to 1000 N)

3.3.3 Creep behaviour

Load per fastening point:

Mounting profile without support	(profile width ≤ 100 mm)	740 N
Mounting profile with support	(profile width > 100 mm)	740 N

Results valid for all materials of load-bearing exterior walls given in Annex A, figure A4.

3.3.4 Wind resistance

Wind pressure-suction alternating load:	± 1000 Pa	maximum position change = 0,6 mm
Wind load static pressure and suction:	± 2000 Pa	maximum position change = 1,1 mm

3.3.5 Burglar resistance

Burglar resistance class: RC 2

3.3.6 Impact loads

Impact load: class 4 (drop height 700 mm)

3.4 Sound insulation (BWR 5)

3.4.1 Weighted sound reduction index

Joint sound reduction index $R_{s,w}$ and the associated spectrum adaptation terms C und C_{tr} of this PWMS given in following table.

Construction joint design 10 mm joint width (3-sided), bottom 0 mm	Mounting profile "blaugelb Triotherm"			
	70 × 85 mm	120 × 85 mm	160 × 85 mm	200 × 85 mm
	$R_{s,w}$ (C;Ctr) in dB	$R_{s,w}$ (C;Ctr) in dB	$R_{s,w}$ (C;Ctr) in dB	$R_{s,w}$ (C;Ctr) in dB
Multifunctional tape	50 (-1; 0)	50 (-1; 0)	43 (0; -1)	43 (0; -1)
Multifunctional belt with 15 mm GKF soffit lining inside	61 (-1; -3)	59 (-1; -3)	52 (0; -2)	52 (0; -2)
Multifunctional tape with Round cord and sealant	60 (-1; -3)	54 (0; -1)	46 (0; 0)	45 (-1; -2)
Multifunctional tape with round cord and sealant with 15 mm GKF soffit cladding inside	61 (-1; -3)	58 (-1; -3)	53 (-1; -3)	49 (-1; -3)
PU foam and sealing foils inside and outside	60 (-1; -3)	---	43 (0; -1)	44 (0; -1)
PU foam and sealing foils inside and outside 15 mm GKF soffit cladding inside	61 (-1; -4)	---	56 (-1; -3)	52 (-1; -3)

3.5 Energy saving and thermal protection (BWR 6)

3.5.1 Thermal conductivity

Thermal conductivity of the profile: $\lambda_{10} = 0,0374$ in W/(mK)

3.5.2 Airtightness of the connection

Length-related air permeability (600 Pa) < 0,19 m³/(h · m)

4 Assessment and verification of constancy of performance (hereinafter AVCP) system applied, with reference to its legal base

4.1 AVCP system

According to Decision of the Commission of 12 Oct 1998 (98/599/EC) (OJ L 287 of 24.10.98, p. 30), as amended by Decision of the Commission of 8 January 2001 (2001/596/EC) (OJ L 209 of 02.08.2001, p. 33), the system of assessment and verification of constancy of performance (see Annex V and Article 65 § 2 to Regulation (EU) No 305/2011) given in the following table applies.

Products	Intended uses	Level or Class	System
Pre-wall mounting kits	For uses subject to reaction to fire	E	System 3
	All other characteristics	-	System 3

5 Technical details necessary for the implementation of the AVCP system, as provided for in the applicable EAD

At the manufacturing plant, the manufacturer has to implement and continuously maintain a factory production control system. All elements, requirements and provisions adopted by the manufacturer in this respect are documented in a systematic manner.

The factory production control system ensures that the performance of the product is in conformity with the European Technical Assessment. If test results are unsatisfactory, the manufacturer shall immediately implement measures to eliminate the defects. Technical details of the actions to be undertaken by the manufacturer in relation to the factory production control are laid down in the control plan deposited at Österreichisches Institut für Bautechnik.

When all criteria of the assessment and verification of constancy of performance are met, the manufacturer shall issue a declaration of performance.

Issued in Vienna on 25.09.2023
by Österreichisches Institut für Bautechnik



Georg Kohlmaier
Deputy Managing Director

ANNEX A

Schematic detail of the product

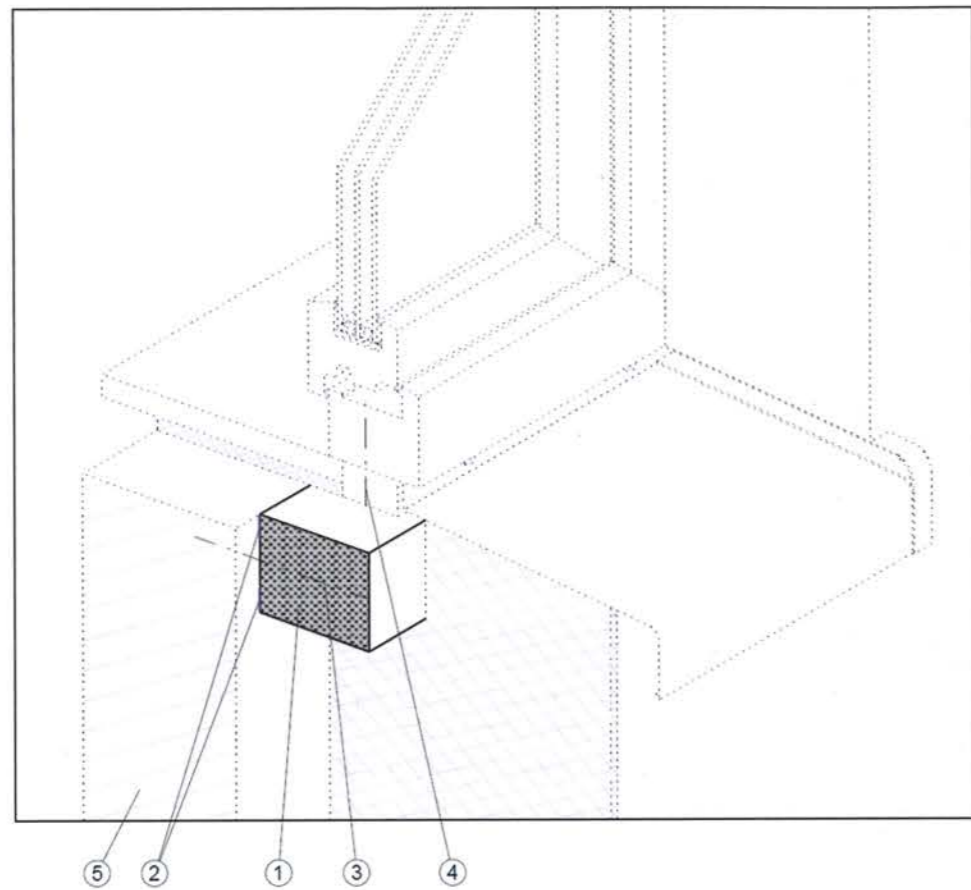

- ① mounting profile „blaugelb Trio**therm**+“
- ② sealing „blaugelb Hybrid Polymer Power Fix“
- ③ connection element „blaugelb Rahmenfixschraube“
- ④ window frame screw „blaugelb Rahmenfixschraube“
- ⑤ load-bearing exterior wall

Figure A1: schematic detail „blaugelb Trio**therm**+ System“

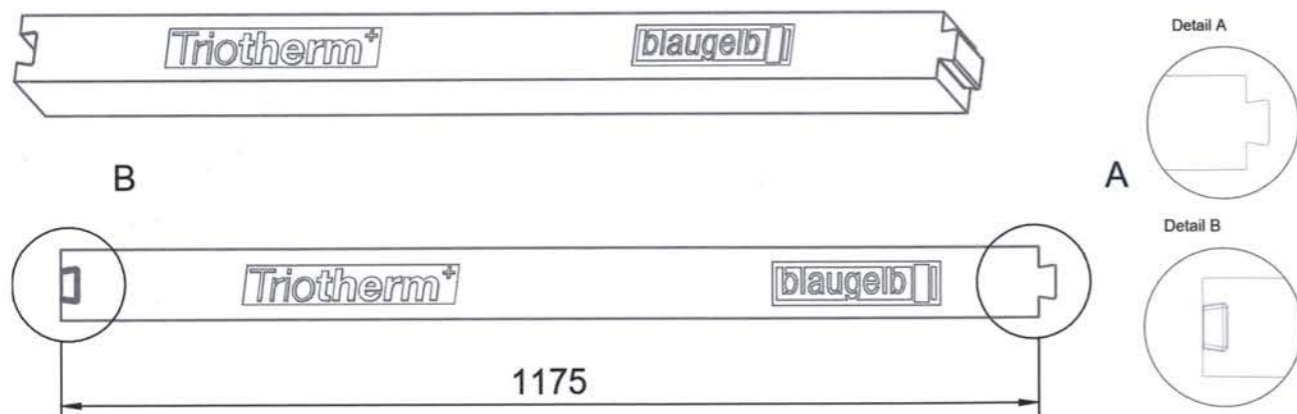
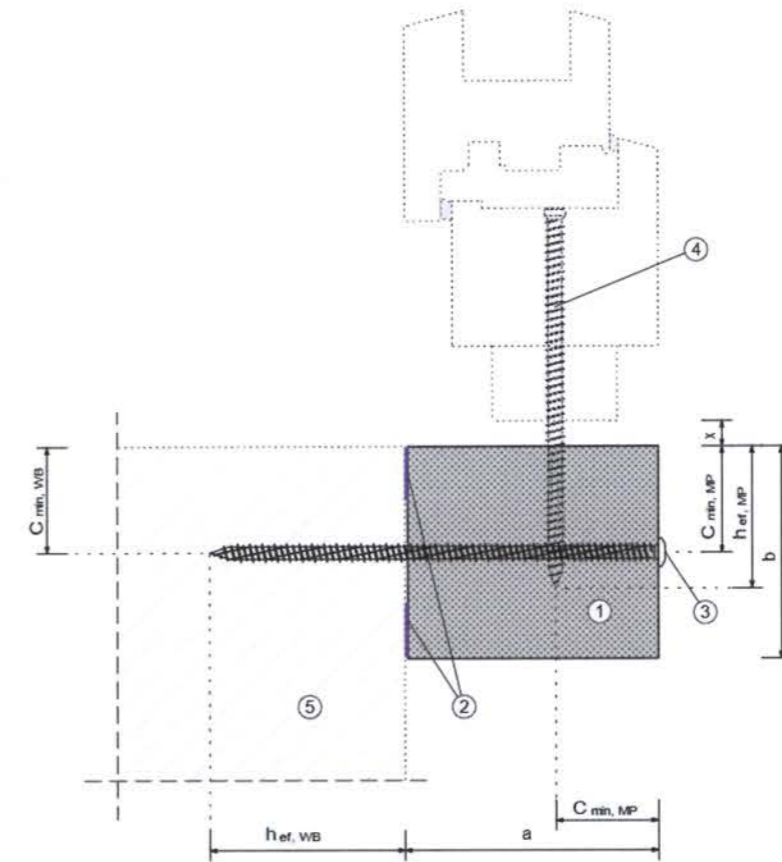

Figure A2: Mounting profile „blaugelb Trio**therm**+“ (A = dovetail; B = pin)



abbreviation	terms	measures
①	mounting profile „blaugelb Trio therm +“	70 × 85 × 1175 mm to 230 × 85 × 1175 mm
②	load-bearing sealing „blaugelb Hybrid Polymer Power Fix“	---
③	force-transmitting connection element „blaugelb Rahmenfixschraube“	Ø 7,5 × length in mm
④	window frame screw „blaugelb Rahmenfixschraube“	Ø 7,5 × length in mm
⑤	load bearing exterior wall	---
a	mounting profile width	70 to 230 mm
b	mounting profile thickness	85 mm
$h_{ef, WB}$	effective anchoring depth in load bearing exterior wall	See table A5
$h_{ef, MP}$	effective anchoring depth in mounting profile	≥ 60 mm: single- and twin screw ≥ 80 mm: twin screw and transverse load $F_{RK} = 2,84$ kN
$C_{min, WB}$	minimum edge distance in load bearing exterior wall	≥ 30 mm
$C_{min, MP}$	minimum edge distance in mounting profile	≥ 30 mm: single screw ≥ 40 mm: twin screw
x	maximum distance of pre-fabricated element to mounting profile	≤ 11 mm or ≤ 21 mm with single screw and twin screw

Figure A3: abbreviation, terms und measures of „blaugelb Trio**therm**+ System“

Figure A4: mounting points of “blaugelb Triotherm+ System” on load-bearing exterior wall

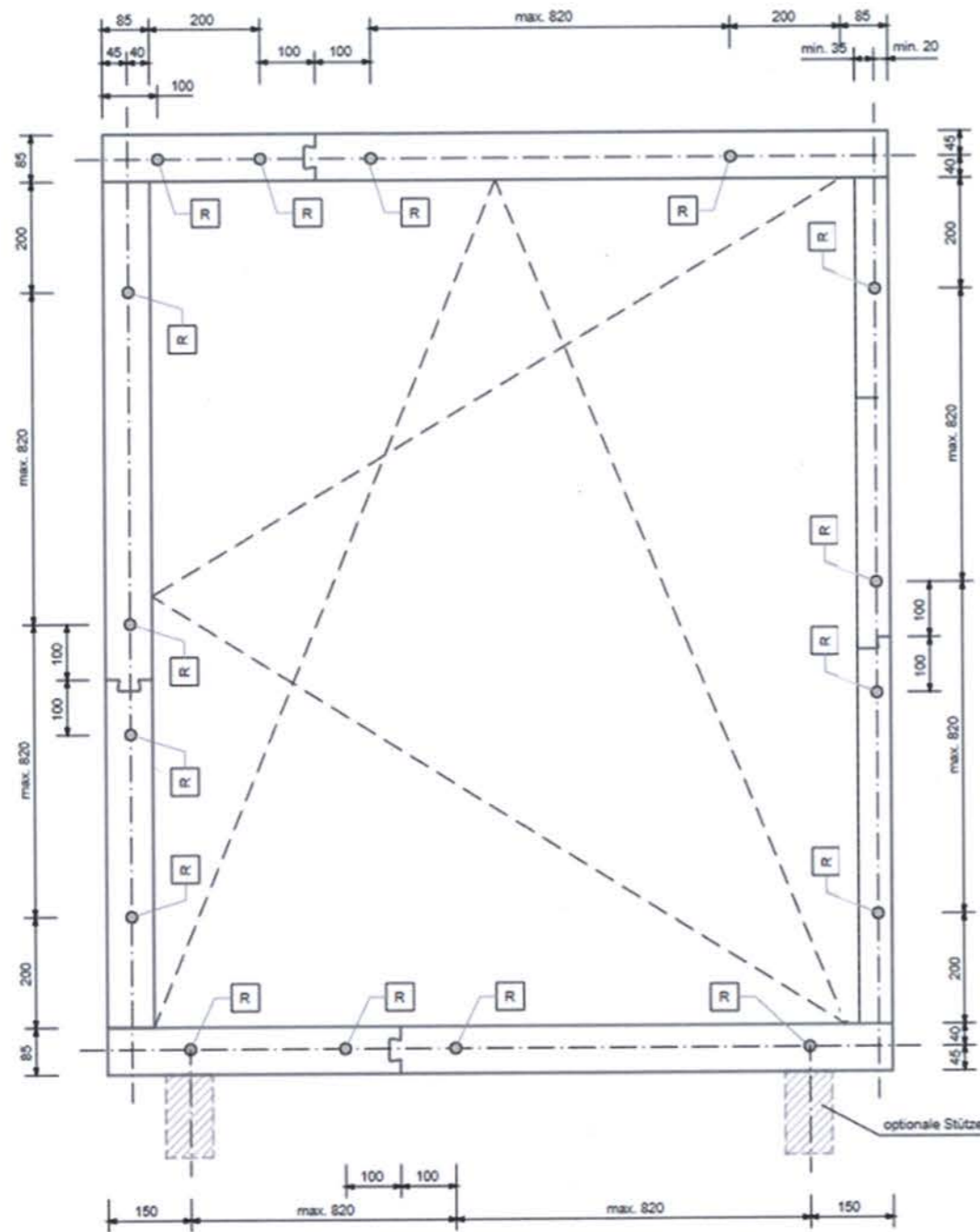

Optional support
Depending on wall structure and forces exerted, see Appendix II: Rated resistances and screw-in depths

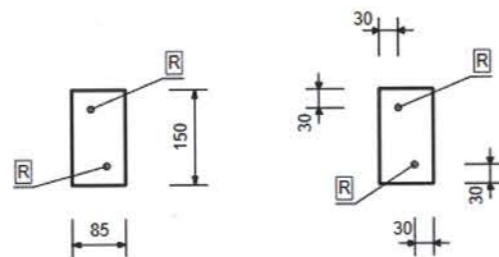

R blaugelb Frame screw Fix FK-T30 7.5 x L
Fixing the Triotherm+ profile in the anchor base

Screw-in depths ($h_{ef, WB}$) into the load-bearing exterior wall

Mounting profile blaugelb Triotherm+	blaugelb Rahmenfixschraube	Exterior load bearing wall material					
		Concrete C25	Sand-lime brick SFK 12	Vertical coring brick SFK 8	Aerated concrete PP4 / PP2	Wood C24	Expand d clay LAC 8
70 x 85 mm	Screw-in depth in mm	min. 40	min. 60	min. 142	min. 142	min. 60	min. 90
	Screw length in mm	112	132	212	212	132	152*
	Pre-drilling in the subsoil	Ø 6 mm	Ø 6 mm	Ø 5 mm	no	Ø 6 mm	Ø 6 mm
80 x 85 mm	Screw-in depth in mm	min. 40	min. 60	min. 142	min. 142	min. 60	min. 90
	Screw length in mm	112*	132*	212*	212*	132*	152**
	Pre-drilling in the subsoil	Ø 6 mm	Ø 6 mm	Ø 5 mm	no	Ø 6 mm	Ø 6 mm
100 x 85 mm	Screw-in depth in mm	min. 40	min. 60	min. 142	mind. 142	min. 60	min. 90
	Screw length in mm	132*	152*	252	252	152*	182*
	Pre-drilling in the subsoil	Ø 6 mm	Ø 6 mm	Ø 5 mm	no	Ø 6 mm	Ø 6 mm
120 x 85 mm	Screw-in depth in mm	min. 40	min. 60	min. 142	min. 142	min. 60	min. 90
	Screw length in mm	182	182	252*	252*	182	212*
	Pre-drilling in the subsoil	Ø 6 mm	Ø 6 mm	Ø 5 mm	no	Ø 6 mm	Ø 6 mm
140 x 85 mm	Screw-in depth in mm	min. 40	min. 60	min. 142	min. 142	min. 60	min. 90
	Screw length in mm	182	212	300	300	212	212**
	Pre-drilling in the subsoil	Ø 6 mm	Ø 6 mm	Ø 5 mm	no	Ø 6 mm	Ø 6 mm
160 x 85 mm	Screw-in depth in mm	min. 40	min. 60	min. 142	min. 142	min. 60	min. 90
	Screw length in mm	212	212*	300	300	212*	252
	Pre-drilling in the subsoil	Ø 6 mm	Ø 6 mm	Ø 5 mm	no	Ø 6 mm	Ø 6 mm
180 x 85 mm	Screw-in depth in mm	min. 40	min. 60	min. 142	min. 142	min. 60	min. 90
	Screw length in mm	212*	252	300**	300**	252	300
	Pre-drilling in the subsoil	Ø 6 mm	Ø 6 mm	Ø 5 mm	no	Ø 6 mm	Ø 6 mm
200 x 85 mm	Screw-in depth in mm	min. 40	min. 60	min. 142	min. 142	min. 60	min. 90
	Screw length in mm	252	252*	350	350	252*	300
	Pre-drilling in the subsoil	Ø 6 mm	Ø 6 mm	Ø 5 mm	no	Ø 6 mm	Ø 6 mm
230 x 85 mm	Screw-in depth in mm	min. 40	min. 60	min. 142	min. 142	min. 60	min. 90
	Screw length in mm	300	300	350**	350**	300	300**
	Pre-drilling in the subsoil	Ø 6 mm	Ø 6 mm	Ø 5 mm	no	Ø 6 mm	Ø 6 mm

*: Profile mounting screws (blaugelb Rahmenfixschraube) 10 mm countersink in “blaugelb Triotherm+ Profil”

** : Profile mounting screws (blaugelb Rahmenfixschraube) 20 mm countersink in “blaugelb Triotherm+ Profil”

Figure A5: Mounting profile “blaugelb Triotherm+”, materials of the load-bearing exterior wall and screw-in depths of “blaugelb Rahmenfixschraube”

ANNEX B

Load-bearing capacity perpendicular to the window plane:

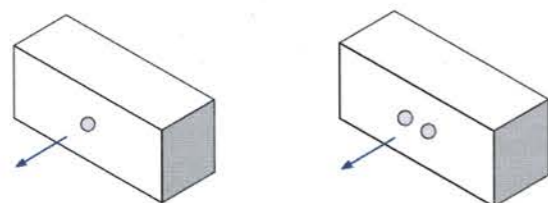

Figure B1: seen from left to right 1 screw, 2 screws,

Table B1: characteristic value of resistance and design load perpendicular to the window plane

F _{Rk} (charact. value of resistance) and F _{Rd} (design load) perpendicular to the window plane								
mounting profile „blaugelb Triotherm“	Exterior load bearing wall material							
	Building material	Concrete	Sand-lime brick	Vertical coring brick		Aerated concrete	Aerated concrete	Wood
	Quality	C25	SFkl. 12	SFkl. 8	SFkl. 12	PP4	PP2	C24
	γ _M	1,8	2,5	2,5	2,5	2	2	1,3
	Unit	in kN	in kN	in kN	in kN	in kN	in kN	in kN
70 x 85 mm 1 screw	F _{Rk}	3,41	7,52	2,68	2,68	2,41	2,41	6,05
	F _{Rd}	1,89	3,01	1,07	1,07	1,21	1,21	4,65
70 x 85 mm 2 screws	F _{Rk}	3,41	7,52	2,68	2,68	2,41	2,41	6,05
	F _{Rd}	1,89	3,01	1,07	1,07	1,21	1,21	4,65
80 x 85 mm 1 screw	F _{Rk}	4,09	7,37	2,92	2,92	2,63	2,63	6,82
	F _{Rd}	2,27	2,95	1,17	1,17	1,32	1,32	5,25
80 x 85 mm 2 screws	F _{Rk}	4,09	7,37	2,92	2,92	2,63	2,63	6,82
	F _{Rd}	2,27	2,95	1,17	1,17	1,32	1,32	5,25
100 x 85 mm 1 screw	F _{Rk}	5,47	7,08	3,39	3,39	3,07	3,07	8,37
	F _{Rd}	3,04	2,83	1,36	1,36	1,54	1,54	6,44
100 x 85 mm 2 screws	F _{Rk}	5,47	7,08	3,39	3,39	3,07	3,07	8,37
	F _{Rd}	3,04	2,83	1,36	1,36	1,54	1,54	6,44
120 x 85 mm 1 screw	F _{Rk}	6,85	6,79	3,86	3,86	3,51	3,51	9,91
	F _{Rd}	3,81	2,72	1,54	1,54	1,76	1,76	7,62
120 x 85 mm 2 screws	F _{Rk}	6,85	6,79	3,86	3,86	3,51	3,51	9,91
	F _{Rd}	3,81	2,72	1,54	1,54	1,76	1,76	7,62
140 x 85 mm 1 screw	F _{Rk}	8,22	6,50	4,33	4,33	3,95	3,95	11,46
	F _{Rd}	4,57	2,60	1,73	1,73	1,98	1,98	8,82
140 x 85 mm 2 screws	F _{Rk}	8,22	6,50	4,33	4,33	3,95	3,95	11,46
	F _{Rd}	4,57	2,60	1,73	1,73	1,98	1,98	8,82
160 x 85 mm 1 screw	F _{Rk}	8,85	6,56	4,26	4,26	4,37	4,37	11,10
	F _{Rd}	4,92	2,62	1,70	1,70	2,19	2,19	8,54
160 x 85 mm 2 screws	F _{Rk}	8,85	6,56	4,26	4,26	4,37	4,37	11,10
	F _{Rd}	4,92	2,62	1,70	1,70	2,19	2,19	8,54
180 x 85 mm 1 screw	F _{Rk}	9,47	6,63	4,19	4,19	4,79	4,79	10,73
	F _{Rd}	5,26	2,65	1,68	1,68	2,40	2,40	8,25
180 x 85 mm 2 screws	F _{Rk}	9,47	6,63	4,19	4,19	4,79	4,79	10,73
	F _{Rd}	5,26	2,65	1,68	1,68	2,40	2,40	8,25
200 x 85 mm 1 screw	F _{Rk}	10,10	6,69	4,12	4,12	5,22	5,22	10,37
	F _{Rd}	5,61	2,68	1,65	1,65	2,61	2,61	7,98
200 x 85 mm 2 screws	F _{Rk}	10,10	6,69	4,12	4,12	5,22	5,22	10,37
	F _{Rd}	5,61	2,68	1,65	1,65	2,61	2,61	7,98
230 x 85 mm 1 screw	F _{Rk}	11,04	6,97	4,02	4,02	5,85	5,85	9,83
	F _{Rd}	6,13	2,79	1,61	1,61	2,93	2,93	7,56
230 x 85 mm 2 screws	F _{Rk}	11,04	6,97	4,02	4,02	5,85	5,85	9,83
	F _{Rd}	6,13	2,79	1,61	1,61	2,93	2,93	7,56

Load-bearing capacity parallel to the window plane:

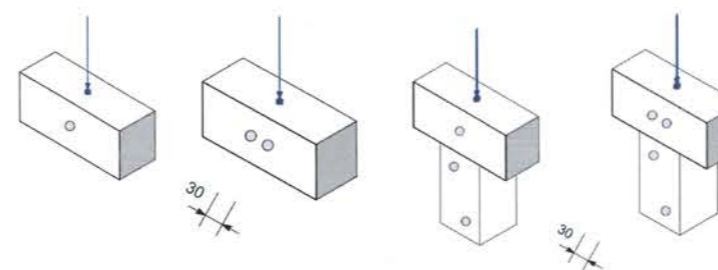

Figure B2: seen from left to right 1 screw, 2 screws, 3 screws and 4 screws

Table B2: characteristic value of resistance and design load parallel to the window plane

F _{Rk} (charact. value of resistance) and F _{Rd} (design load) parallel to the window plane.									
mounting profile „blaugelb Triotherm“	Exterior load bearing wall material								
	Building material	Concrete	Sand-lime brick	Vertical coring brick		Aerated concrete	Aerated concrete	Wood	Expanded clay
	Quality	C25	SFkl. 12	SFkl. 8	SFkl. 12	PP4	PP2	C24	LAC 8
	γ _M	1,8	2,5	2,5	2,5	2,0	2,0	1,3	2,0
	Unit	in kN	in kN	in kN	in kN	in kN	in kN	in kN	in kN
70 x 85 mm without support 1 screw	F _{Rk}	4,69	2,68	2,38	2,38	2,50		3,83	
	F _{Rd}	2,61	1,07	0,95	0,95	1,25		2,95	
70 x 85 mm without support 2 screws	F _{Rk}	4,97	4,67	4,08	4,08	2,50		3,97	
	F _{Rd}	2,76	1,87	1,63	1,63	1,25		3,05	
70 x 85 mm with support Stütze 150x70x85 mm 3 screws	F _{Rk}	7,87	15,08	5,42	5,42	6,31			5,35
	F _{Rd}	4,37	6,03	2,17	2,17	3,16			2,68
70 x 85 mm with support 150x70x85 mm 3 screws	F _{Rk}	7,87	17,11	5,89	8,05	6,31			6,78
	F _{Rd}	4,37	6,84	2,36	3,22	3,16			3,39
80 x 85 mm without support 1 screw	F _{Rk}		3,51			1,50		3,83	
	F _{Rd}		1,40			0,75		2,95	
80 x 85 mm without support 2 screws	F _{Rk}		4,82						
	F _{Rd}		1,93						
80 x 85 mm with support 150x80x85 mm 3 screws	F _{Rk}		13,06	5,42					
	F _{Rd}		5,22	2,17					
100 x 85 mm without support 1 screw	F _{Rk}		3,51			1,50		3,83	
	F _{Rd}		1,40			0,75		2,95	
100 x 85 mm without support 2 screws	F _{Rk}	3,15	4,82			1,50		3,97	
	F _{Rd}	1,75	1,93			0,75		3,05	
100 x 85 mm with support 150x100x85 mm 3 screws	F _{Rk}	7,87	13,06	5,42	5,42	5,53	3,38	11,09	5,35
	F _{Rd}	4,37	5,22	2,17	2,17	2,77	1,69	8,53	2,68
120 x 85 mm without support 1 screw	F _{Rk}		1,97						
	F _{Rd}		0,79						

F _{Rk} (charact. value of resistance) and F _{Rd} (design load) parallel to the window plane.									
mounting profile „blaugelb Triothersm“	Exterior load bearing wall material								
	Building material	Concrete	Sand-lime brick	Vertical coring brick		Aerated concrete	Aerated concrete	Wood	Expanded clay
	Quality	C25	SFkl. 12	SFkl. 8	SFkl. 12	PP4	PP2	C24	LAC 8
	γ _M	1,8	2,5	2,5	2,5	2,0	2,0	1,3	2,0
Unit	in kN	in kN	in kN	in kN	in kN	in kN	in kN	in kN	in kN
120 x 85 mm without support 2 screws	F _{Rk}		3,10						
	F _{Rd}		1,24						
120 x 85 mm with support 150x120x85 mm 3 screws	F _{Rk}	4,36	12,43	5,42	5,42	5,53	3,38	11,09	5,35
	F _{Rd}	2,42	4,97	2,17	2,17	2,77	1,69	8,53	2,68
120 x 85 mm with support 150x120x85 mm 4 screws	F _{Rk}	4,36	11,04	5,42	5,42	5,53	3,38	11,09	6,78
	F _{Rd}	2,42	4,42	2,17	2,17	2,77	1,69	8,53	3,39
120 x 85 mm with support 200x120x85 mm 4 screws	F _{Rk}	4,36	13,25	5,42	8,05	5,53	3,38	11,09	
	F _{Rd}	2,42	5,30	2,17	3,22	2,77	1,69	8,53	
140 x 85 mm without support 1 screw	F _{Rk}		1,97						
	F _{Rd}		0,79						
140 x 85 mm without support 2 screws	F _{Rk}		3,10						
	F _{Rd}		1,24						
140 x 85 mm with support 150x140x85 mm 3 screws	F _{Rk}	4,36	8,31	3,86	3,86	5,02	2,99	10,81	5,35
	F _{Rd}	2,42	3,32	1,54	1,54	2,51	1,50	8,32	2,68
160 x 85 mm with support 150x160x85 mm 3 screws	F _{Rk}	4,36	6,69	3,86	3,86	5,02	2,99	10,81	5,35
	F _{Rd}	2,42	2,68	1,54	1,54	2,51	1,50	8,32	2,68
160 x 85 mm with support 150x160x85 mm 4 screws	F _{Rk}	4,36	9,32	5,89	8,05	5,02	2,99	10,81	6,78
	F _{Rd}	2,42	3,73	2,36	3,22	2,51	1,50	8,32	3,39
180 x 85 mm with support 150x180x85 mm 4 screws	F _{Rk}		9,32	6,98	6,98	3,75	3,75		
	F _{Rd}		3,73	2,79	2,79	1,88	1,88		
200 x 85 mm with support 150x200x85 mm 4 screws	F _{Rk}		9,32	6,98	6,98	3,75	3,75	9,57	
	F _{Rd}		3,73	2,79	2,79	1,88	1,88	7,36	
200 x 85 mm with support 150x200x85 mm 3 screws	F _{Rk}		6,92					9,57	
	F _{Rd}		2,77					7,36	
230 x 85 mm with support 200x230x85 mm 4 screws	F _{Rk}		8,66						
	F _{Rd}		3,46						
230 x 85 mm with support 200x230x85 mm 3 screws	F _{Rk}		8,66						
	F _{Rd}		3,46						
230 x 85 mm with support 200x230x85 mm 3 screws	F _{Rk}		6,92						
	F _{Rd}		2,77						

ANNEX C

Installation of “blaugelb Triothersm+ System”

General information:

The installation of “blaugelb Triothersm+ System” shall be done according to the installation instructions of the manufacturer. For detailed information of assembly see the installation instructions of the manufacturer.

The “blaugelb Triothersm+ profiles” have to be attached to the building structure before the general installation work starts.

Corner constructions and butt joints:

The minimum length of the “blaugelb Triothersm+ profiles” for extending is 250 mm.

An endless extension of the “blaugelb Triothersm+ profiles” may be done by dovetail connection. The “tine” is positioned on the wall side (at the bottom). The dovetail is pressed into the “tine” from above.

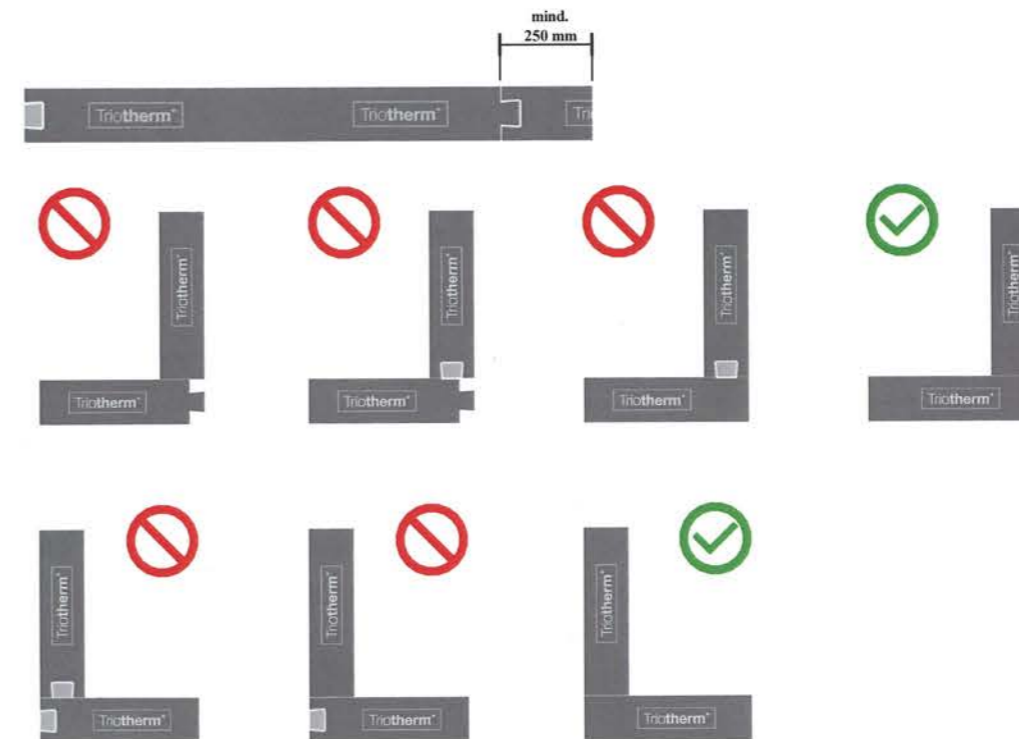

Step by step of Assembly:

- Examination of the substrate (flatness, dimension tolerances and masonry tolerances, etc.)
- Check of the load-bearing substrate for loose components, bituminous and/or separating coatings. Separating layers shall be removed, e.g., with a diamond grinding bowl
- Normal construction dust on the surface has to be bound/removed
- Assembly of profiles
- Application of waterproofing
- Attaching the profiles to the anchoring surface
- Screwing the profiles

Edge spacing of the blaugelb Trio**therm**⁺ pre-wall mounting kit:

- ⑤ blaugelb sealing Tape TrioSDL600
- ⑩ blaugelb Hybrid Polymer Power Fix
- ⑭ blaugelb Frame fixed screw ZK-T30 7,5 x L
- ⑮ blaugelb Frame fixed screw FK-T30 7,5 x L
- ⑳ blaugelb Trio**therm**⁺ Profile 70x85 mm
- ⑤① load-bearing wall construction

